

Errata

Note: This Page 03 must be filed immediately in front of Page 1, Issue 2 dated 31 Jan 68.

(The following amendment must be made to this regulation).

36. Page 27 para 65.f.

Adjacent to f. add '*'

37. At foot of page add 'Note * When fitting Mod Inst No 5 or re-aligning channel frequencies below 265MHz, it will be necessary to reduce the excessive tuning capacitance by removing the 8pf parallel capacitor C329a if this has not already been done'.

T/61134/11/Tels

The information given in this document is not to be communicated, either directly or indirectly, to the Press or to any person not authorized to receive it.

CONDITIONS OF RELEASE

(Applicable to copies supplied with Ministry of Defence approval to Commonwealth and Foreign Governments)

1. This document contains classified UK information.
2. This information is disclosed only for official use by the recipient Government and (if so agreed by HM Government) such of its contractors, under seal of secrecy, as may be engaged on a defence project. Disclosure or release to any other Government, national of another country, any unauthorized person, the Press, or in any other way would be a breach of the conditions under which the document is issued.
3. This information is to be safeguarded under rules designed to give the same standard of security as those maintained by HM Government in the UK.

STATION, RADIO, A43R Mk 2 MANPACK/GROUND

TECHNICAL HANDBOOK - FIELD AND BASE REPAIRS

This EMER must be read in conjunction with F 532 Part 2 which contains figures and tables to which reference is made

Note: This Issue 2, Pages 1 to 4 supersede Issue 1, Pages 1 to 4 dated 23 Oct 67. Para numbers have been amended and Table and Figure page numbers inserted.

CONTENTS

	<u>Para</u>
INTRODUCTION	1
INSTRUCTIONS FOR OPENING DRYING AND RESEALING	2
MECHANICAL REPAIRS AND REPLACEMENTS	
General precautions	11
To remove p.s.u. from chassis assembly	15
To remove front panel assembly	16
Refitting front panel assembly	17
Removal of transformer T204 from main chassis assembly	18
To remove the receiver deck from the main chassis assembly	19
To fit the receiver deck into the main chassis assembly ..	20
To remove the transmitter deck from the main chassis assembly	21
To fit the transmitter deck into the main chassis assembly	22
To remove the turret drum	23
To fit the turret drum	24

	<u>Para</u>
Relay repairs	25
A43R battery adaptor	26
A43R battery charger	27
GENERAL	29
TEST CONDITIONS	35
CURRENT CONSUMPTION	45
TRANSMITTER TESTS	
Frequency accuracy	46
RF power output	47
Modulation percentage and speech clipping efficiency	48
Beacon tone frequency	49
Condition indicator	50
Receive to transmit delay time	51
Receiver tests	
Sensitivity/signal to noise ratio/automatic gain control	52
Image rejection	53
1st oscillator/oscillator multiplier frequency accuracy	54
2nd oscillator frequency accuracy and output	55
BATTERY CHARGER TESTS	56
BATTERY ADAPTOR TESTS	57
A43R BATTERY TESTS	58
ANTENNAE	
A43R Whip (tape) antenna	59
A43R Discone antenna	60
CABLE ASSEMBLY R.F.	61

ELECTRICAL ADJUSTMENTS AND ALIGNMENT

GENERAL	62
TRANSMITTER	
Frequency and r.f. power output	63
Frequency	64
RF power output	65
Transmitter modulator clipper stages	66
Condition indicator	67
RECEIVER	
2nd oscillator	68
IF amplifiers	69
2nd i.f. amplifier	70
1st i.f. amplifier	71
IF amplifier response curve by wobulation	72
Mechanical adjustment of i.f. amplifier trimmers	73
IF amplifier alignment by wobulation	74
1st oscillator/oscillator multiplying stages	75
RF alignment	76

FAULT FINDING INFORMATION

TRANSMITTER	77
MODULATOR	78
RECEIVER	79
Protection circuit efficiency	81
Audio stage response	82

POWER SUPPLY UNIT
Output voltages	83
Output current and ripple voltage	84
BATTERY CHARGER	87

LIST OF FIGURES

<u>Fig</u>		<u>Page</u>
1	Transmitter performance specification, test layout (set cased)	14
2	Receiver performance specification, test layout (set cased)	18
3	Receiver 1st oscillator multiplier stages, specification test layout (set open)	20
4	Transmitter alignment, test layout	26
5	Transmitter speech clipper/beacon tone, test layout	29
6	Receiver i.f. amplifiers alignment test layout (set open)	31
7	Typical overall response, i.f. stages	33
8	Receiver i.f. alignment, wobulation test layout	35
9	Receiver r.f. alignment, test layout	37
10	Modulator, test layout	40
11	Modulator, test connection detail	42
12	AF response, test layout	44
13	Power supply unit, test layout (A43R load)	46
14	Power supply unit, test layout (resistive load)	47
15	Power supply unit, waveforms and ripple characteristics	49
16	Battery charger waveform	50
4001	Battery charger, layout of fittings	1001
4002	A43R valve and semi-conductor diode, connection details	1002
4003	A43R semi-conductor, connection details	1003
4004	A43R supply unit resistive load details	1004
4005	Sweep source for external modulation of Signal generator No 18	1005
4006	Relay RLC, location	1006
4007	Turret trimming tool	1007
4008	IF trimming tool	1008
4009	Channel tuner (biscuit) removing tool	1008
4010	Receiver contacts	1009
4011	Channel tuner in goal post assembly	1010

LIST OF TABLES

<u>Table</u>		<u>Page</u>
1	Test equipment schedule - ARMY	10
2	Test equipment schedule - NAVAL equivalents to Table 1	11
3	Test equipment schedule - RAF equivalents to Table 1	12
4	A43R current consumption	13
5	Transmitter, typical test readings	39
6	Modulator and speech clipper, typical test readings	39
7	Receiver, typical test readings	41
8	Battery charger, voltage and current readings	50

INTRODUCTION

1. The repair policy of this equipment is as follows:-
 - a. Field repairs entail adjustment or replacement of faulty components in the transmitter r.f. or modulator circuitry and the receiver r.f. or a.f. circuitry. The receiver 2nd oscillator, 2nd mixer, filter i.f., amplifier i.f. and detector stage assemblies are encapsulated during manufacture. Component repairs or replacements cannot be carried out in these stages which must be replaced as a whole stage should a fault therein develop.
 - b. Base repairs normally include:-
 - (1) Those repairs beyond the capacity of Field Workshops because of time, test equipment and spares.
 - (2) Complete overhauls.
 - (3) Programme repairs or modifications.

INSTRUCTIONS FOR OPENING, DRYING AND RESEALING

2. Instructions for opening and the precautions to be taken when removing the set from its case are detailed in EMER Tels F 533.
3. The set is only to be opened for repairs where conditions exist for drying and resealing to an approved standard. The battery charger unit is not sealed.
4. When received for repair, the set must be pressurised to 5 lb/sq. in. using the Leak locator CT509, and a dip test carried out in a water tank to check for pin holes in the casting and case and for leaks around controls etc. denoting faulty seals and gaskets. The set should remain immersed for about five minutes. The addition of a wetting agent to the water is recommended.
5. The set is to be opened and all obvious mechanical repairs, component replacement and mechanical adjustments carried out.
6. When removed from its case the set must then be placed in the Oven, drying tele-communications for a period of at least two hours at 50 deg C with dry air from the pump unit passing through the oven. After cooling, it must be electrically tested and any necessary realignment or repairs carried out.
7. As soon as possible after alignment, the set must be resealed into its case the gasket of which must first be given a thin smear of silicone grease (H1/6850-99-942-3548).
8. The set with desiccator removed must be replaced in the oven for a period dependent upon local humidity conditions but not normally in excess of 30 minutes.
9. Using leak locator, raise the internal pressure 5 lb/ sq. in above atmospheric pressure using the dry air from the oven. After a period of 24 hours the pressure must not have fallen below $4\frac{1}{4}$ lb/sq. in. (see EMER Tels M 631 for details of temperature correction). The set has a time constant of 150 hours.

10. Remove the set from the leak locator, fit a new desiccator and check the operation of the set.

MECHANICAL REPAIRS AND REPLACEMENTS

General precautions

11. The "Warnings" given in EMER Tels F 532 Part 1 and 533 must be read before commencing repairs to the A43R.

12. When removing the chassis from the case, as shown in EMER Tels F 532, take care not to damage the PA valve V306 by contact with the flange of the case.

13. Care must also be exercised when hinging the transmitter deck to prevent damaging the PA tank coil assembly, L307 and 8. L309 must not be disturbed or the critical adjustment will be impaired.

14. Great care must be exercised when soldering and attention is drawn to EMER Tels A 522, Miniature repair techniques.

To remove p.s.u. from chassis assembly

15. a. Using a wrench, set screw 3/32 in., undo the four socket-headed No 4 BA screws securing the p.s.u. to the chassis electrical equipment.

b. The p.s.u. can now be removed by pulling it away from the chassis connector PLB.

c. Replacement is by reversal of the above procedure.

To remove front panel assembly

16. a. Release the 14 pole connector PLK (see Tels F 533 para 23) and co-axial connector SKT-J.

b. Using a wrench set screw 5/32 in. unscrew the seven socket headed screws securing the front panel assembly. With a wrench set screw 3/32 in. undo the two hexagon headed screws (these flank the channel selection knob).

c. Exercise care when lifting the front panel away in order that the connecting wires do not foul other components on the main chassis assembly.

Refitting front panel assembly

17. a. Match up the ends of the turret shaft and channel selector knob so that the steps of the couplings are in alignment. It may be necessary to dress the wiring of the front panel so that it lies below the fixing bosses. Place the front panel on the main chassis assembly so that the socket screws locate in the tapped studding.

b. Ensure that the system switch wiring is not trapped between the bosses of the front panel and the tapped studding before securing the panel socket headed fixing screws.

c. Reconnect the 14 pole connector PLK and the coaxial connector SKT-J.
Do not overtighten SKT-J.

d. Check that the channel selector operates effectively.

Removal of transformer T201 from main chassis assembly

18. Disconnect the leads to the top of the transformer using a miniature iron. Unsolder the fixing lugs from the back plate using heavy-duty soldering iron to overcome heat loss to the chassis. Remove the transformer.

To remove the receiver deck from the main chassis assembly

19. a. Disconnect the 14 pole connector PLF and the coaxial connector SKT-E.

b. Using a wrench set screw 3/32 in. undo the four socket headed No 4 BA screws securing the receiver deck to the main chassis assembly.

c. With a wrench set screw 7/64 in. loosen the hexagon locking screws which secure the hinge-posts (two No 4 BA machine screws) of the receiver deck.

d. The two No 4 BA machine screws, which form the receiver deck hinge-posts are now unscrewed and this allows the receiver deck to be removed from the main chassis assembly.

To fit the receiver deck into the main chassis assembly

20. The procedure in para 21 is carried out in the reverse order.

To remove the transmitter deck from the main chassis assembly

21. a. Disconnect the 14 pole connector PLD and the coaxial connector SKT-C.

b. Follow the instructions in para 21 b, c. and d., substituting the word 'transmitter' for the word 'receiver' whenever it occurs.

To fit the transmitter deck into the main chassis assembly

22. The procedure in para 23 is carried out in the reverse order.

To remove the turret drum
(Intermediate and Base repairs)

23. a. Switch the channel selector to channel 3.

b. The front panel, the p.s.u., the transmitter deck and the receiver deck must be removed from the main chassis assembly.

c. Unsolder the leads attached to the battery connector PLA in the Support, power supply. Note that the mauve lead is negative and the two black leads are positive. Push the rubber grommet and leads through to the turret drum side of the Support, power supply.

- d. Remove the No 4 BA screws securing the stays to the end section.
- e. Remove the screws securing the red, plug electrical, PLB, and remove the Support, electrical chassis.
- f. Partially unscrew the No 4 BA screw securing the stay, carrying the cable loom on the Chassis, electrical equipment. The Support, power supply, can now be lifted from the Shaft, turret assembly.
- g. Unscrew the No 4 BA nut on the Pivot, eccentric, which secures the Spring, helical extension.
- h. The Ring, retaining, must now be removed from the Shaft, turret assembly and this will allow the turret drum to be taken out.

To fit the turret drum
(Intermediate and Base repairs)

24. The procedure in para 25 is carried out in the reverse order. Note that the bearings of the turret shaft and the roller on the spring assembly must be lubricated with grease MS4 (4850-99-220-2421) before re-assembly.

Relay repairs

25. Relay RLC is of sealed construction and will be replaced at Field or Base if defective. Relay RLA is of miniature type and will not normally require adjustment. If the operating coil is defective or the relay has been mechanically damaged, replacement action will be taken.

A43R battery adaptor

26. To obtain access to the relay RLA and the semi-conductor diode MR1, remove the two No 6 BA bolts securing the relay housing and carefully lift off the hexagon studding. It will then be necessary to remove the two No 6 BA screws securing the relay bracket of the housing. The relay RLA and semi-conductor diode MR1 can then be serviced. Fig 3, EMER Tels F 532 Part 1 shows RLA and MR1 exposed.

A43R battery charger

27. The battery charger is removed from its case by removing the anti-tamper caps and undoing the four socket-headed No 2 BA steel screws.

28. To obtain access to the meter (M501), indicator lamp ILP501, and d.c. output connector SKT-A, it will be necessary to remove the screws securing the vertical sub-chassis and the No 4 BA lock nuts securing the hexagon section pillars before attempting to lift the sub-assemblies from the front panel, the layout of the fixings is shown in Fig 4001.

SPECIFICATION TESTS

GENERAL

29. The tests shown in this regulation are those which are necessary to prove the serviceability of an equipment. When a T/R A43R is being inspected it is only

necessary to carry out those tests detailed in para 47 to 55. After repair, the additional specification tests in para 56 to 57 are to be carried out.

30. All testing and alignment instructions are based on the use of the Test kit, radio SR A43R Mk 2 together with the items of test equipment detailed in Table 1.

31. The Test kit, radio, SR A43R is separately described in EMER Tels M 192. The Test set, radio, referred to in later paragraphs is part of this test kit.

32. When a test kit is not available, testing may be carried out by dismantling the handset to obtain access to the audio circuits.

33. Later models of the A43R Mk 2 have circuit changes incorporated by the manufacturer. These are tailed in EMER Tels F 532 Parts 1 and 2. Where specification figures and procedures differ, both will be detailed in this regulation.

34. The later models are identified by the modification record plate showing the figure 3 struck through (~~3~~). The receive to send delay time is reduced to a period shorter than that existing after the completion of Modification Instruction No 2.

TEST CONDITIONS

35. It is important that the input supply is adjusted to produce the following levels on load and that they are maintained during all subsequent testing.

Receive	12V d.c.)	indicated on Test Set, Radio, voltmeter
Transmit	11.5V d.c.)	

36. The supply voltages are to be obtained from an approved stabilized transistor supply unit or in an emergency, from the set battery. The battery superseder must not be used as the transient spikes it produces may damage the transistors. If the A43R test kit is not available and an external supply is used great care must be taken to ensure correct polarity.

37. Certain tests are specified to be carried out at the highest and lowest frequencies. When a set is sealed, these will be the highest and lowest channel frequencies fitted. When a set is open, the highest and lowest frequency tuners are to be fitted. For Army A43R Mk 2 sets, these are 243Mc/s and 282Mc/s respectively.

38. The spare channel tuners are each individually aligned to the parent radio set. If repairs have been carried out to the r.f. circuitry, each channel tuner will require specification testing.

39. All A43R channels are crystal controlled and frequency accuracy is of paramount importance. If a channel frequency is outside specification tolerance no further testing is to be carried out until the frequency error is corrected. If all six channels are outside specification limits it is evident that the r.f. circuitry has become mistuned and all channel tuners, including the 18 spare channels require realignment.

40. Receiver testing is to be carried out with the signal generator set accurately to the appropriate channel frequency by means of a frequency counter. It is

recommended that the signal generator is first set approximately to the correct frequency by injecting a modulated signal into the A43R and tuning the signal generator for an audible note in the headset. Final setting is carried out by transferring the signal generator output, now unmodulated, to the frequency counter. The level will have to be adjusted accordingly. In the case of the CT 394B the frequency should be set to the appropriate channel frequency $f \pm 2\text{kc/s}$, this being the practical limit of accuracy available. The Signal generator No 15 should be set to $f \pm 10\text{kc/s}$ as the fine testing of the tuning control and stability is not as good. It will be found that the A43R connector No 11 which is connected to the signal generator output lead, fits the counter input socket and the output is quite satisfactory for setting the correct frequency of the Signal generator No 15.

41. The counter and signal generator must be switched on and allowed to warm up for at least one hour before any measurements are taken. The counter must only be connected to a test point on the A43R when that particular stage is being measured and disconnected when other stages are being checked.

42. If the signal generator has a 'HIGH OUTPUT' connection to drive the counter it is not necessary to disconnect it from the A43R while frequency checks are being made (para 42). It is essential, however, to disconnect the counter and cap the 'HIGH OUTPUT' socket while level measurements are being made.

43. Receiver sensitivity tests are carried out using the Signal generator CT 394B and figures are quoted in μV , or the Signal generator No 15 and the Modulator amplitude TF 1102, when figures are quoted in dBs. The output of the Signal generator No 15, when directly modulated, has a high f.m. content. This gives incorrect results and it is necessary to use the Modulator amplitude to carry out post attenuation modulation. The Modulator amplitude has an insertion loss of approximately 20dB and it will be found that an attenuation setting of 69-70dB is equivalent to $5\mu\text{V}$.

44. For a modulation depth of 30% at 1000c/s indicated on the Modulator amplitude, the audio generator is to be set to a low impedance and the Modulator amplitude 'MOD TERMINATION' switch set to 75 ohms. The valve voltmeter monitoring the a.f. will read approximately 260mV.

Table 1 - Test equipment schedule (ARMY)

Item	Preferred instrument		Suitable alternative	
	Part No.	Designation	Part No.	Designation
1	Z4/6625-99-106-1189	Signal generator set CT394B	Z4/6625-99-901-9983 Z4/ZD 00425 Z4/6625-99-949-2037	Signal generator set CT394A Signal generator No 15 } used together Modulator amplitude
2	Z4/6625-99-103-6633	Signal generator No 18 CT402		
3	Z4/6625-99-102-8077	Signal generator No 12/2		
4	Z4/ZD 04247	Signal generator video frequency No 1 CT416	Z4/ZD 00198	Oscillator beat frequency No 8
5	Z4/6625-99-106-3438	Power supply set, Solartron, AS1412/M		
6	Z4/6625-99-933-1822	Counter frequency meter		
7	Z4/6625-99-104-5121	Converter, electronic frequency (Marconi TF2400/1)		
8	Z4/6625-99-955-6255	Multimeter, electronic CT471C (Bradley 113/S)	Z4/6625-99-972-0247	Multimeter, electronic CT471
9	Z4/6625-99-943-2419	Test set, electronic, valve CT160		
10	Z4/6625-99-105-6320	Test kit radio, TRA43R Mk 2	Z4/6625-99-103-5993	Modulation test set, Almeo type 210
11	Z4/6625-99-105-7106	Meter set modulation, CT542		
12	Z4/5915-99-104-9712	Adaptor, impedance matching co-axial, T shape		
13	Z4/6625-99-949-0510	Wattmeter, absorption, a.f. No 1 CT44		
14	Z4/6625-99-943-5568	Wattmeter, absorption, CT419 equipment		
15	Z4/6625-99-102-6694	Oscilloscope set CT436 with probe	Z4/6625-99-949-1999	Multimeter set CT498
16	Z4/6625-99-105-7049	Multimeter set CT498A		
17	Z4/6625-99-949-0872	Test set, transistor, CT446		
18	Z4/6625-99-200-2271	Leak locator, CT509		
19	W3/4440-99-201-3049	Dehumidifier desiccant electric No 2 Mk 1	W3/6625-99-942-4825	Dehumidifier desiccant electric No 1 Mk 1

Table 2 - Test equipment schedule - NAVAL equivalents to Table 1

Item	N.A.T.O. Cat No	Description	Remarks
1	6625-99-972-6346	Signal generator CT394A	R.F. signal source covering 200 to 300Mc/s for overall performance checks and realignment using internal amplitude modulation of 1kc/s in lieu of Modulator, amplitude, TP1102
2	ZD 00784	Test oscillator, portable CT212	1st i.f. signal source 19.05Mc/s f.m./a.m. for i.f. check and realignment
3	ZD 00784	Test oscillator, portable CT212	2nd i.f. signal source 930kc/s for i.f. check and alignment
4	} 6625-99-943-4059	Signal generator CT433	Audio oscillator for audio checks in 300-30000e/s range
6/7	6625-99-971-8519	Digital frequency counter CT488 with 100Mc/s adaptor	Present limit 100Mc/s. Future adaptor will extend range
8	6625-99-972-0247	Multimeter, electronic CT471	Alignment and performance testing
9	6625-99-943-2419	Test set, electronic valve, CT160	Testing of transmitter valves
10	Z4/6625-99-105-6320	Test kit, radio; TR443R Mk 2	As shown in ARMY schedule
11	6625-99-943-2784	Test set (Radio) CT214	Transmitter testing
13	6625-99-949-0510	Wattmeter, absorption A.F. No 1 CT44	A.F. output wattmeter for overall performance checks setting up and realignment of receiver unit
14	6625-99-943-2784	Test Set (Radio) CT214	UHF power output meter for overall performance checks
15	6625-99-914-2605	Oscilloscope CT436 (without accessories of 6625-99-913-8618)	I.F. alignment and speech clipper adjustments
16	} 6625-99-943-1524	Multimeter model 8S	Power supply checks, d.c., levels etc.
17	6625-99-519-4000	Test set, transistor CT537	General purpose transistor test set

N.B. Not all ships carrying the S.R.43R Mk 2 (Naval Type 634) will be entitled to the items of C.R.E.T.F. scheduled above - this schedule is not to be construed as authority to demand C.R.E.T.F. in excess of normal allowance.

Table 3 - Test equipment schedule - R.A.F. equivalents to Table 1

Item	Cat ref No	Description	Remarks
1	10/S17134 6625-99-972-6436	Signal generator, CT994A (TP801D/2/S) Set	R.F. signal source 200-300Mc/s for overall performance checks and realignment using internal amplitude modulation of 1kc/s
2	10S/172C 6625-99-944-7566	Signal generator, 9208B (TP995A/2/M) Set	1st i.f. signal source 19.05Kc/s f.m./a.m., for i.f. check and realignment with ROBUSTATION
3	10S/16780	Signal generator, CT218 (TP937)	2nd i.f. signal source 930kc/s, for i.f. checks and realignment
4	10S/9449754	Wide range RC osc audio and video TP1370	Audio osc 300-3000c/s for audio checks and setting up speech clipper
5	10K/ (10S/9331822 (S1/1) 10S/9331823 (S2/1) 10S/9331824 (S5/1) OR 10AF/9701766 as item 7 Table 2515	Stabilized power supply 0-30V, 5A, max ripple 1mV (STARTRONIC POWER PACK) Frequency counter, 300Mc/s upper frequency Accuracy 1 in 10 ⁶ . Counts of 1 to 10 secs Input sensitivity less than 100mV. Input impedance greater than 10Ω. (Marconi TP1417/2 with 5000Mc/s converters) Multimeter, electronic, CT471. (Bradley type 113/S)	Current required 4A. Current limit protection required Used for frequency checks of channel fundamental frequencies, also 2nd oscillator, and for final radiated and received channel frequencies Alignment and performance testing
8	6625-99-972-0247	Multimeter, electronic, CT471. (Bradley type 113/S)	Alignment and performance testing
9	6625-99-943-2419	Test set, electronic valve, Avo, type CT160	Transmitter valves A43R, Mk 2
10	Z4/6625-99-105-6320	Test Kit radio, TR143R Mk 2	As shown in ARMY schedule
11	Z4/6625-99-103-5993	Test set modulation. Frequency range 2.25-300Mc/s. Modulation a.m. 0-100% peak and trough. (Airmec 210)	Transmitter testing (I.F. output to oscilloscope CT436)
13	6625-99-949-0510	Wattmeter, absorption, a.f., No 1, CT44	A.F. output wattmeter for overall performance checks, setting up and realignment of receiver unit
14	6625-99-943-5568	Wattmeter, absorption, v.h.f., CT419, TP1152/1	U.H.F. power output meter, for overall performance checks, setting up and realignment of the transmitter. 50Ω input
15	6625-99-913-8618	Oscilloscope, set, CT436	I.F. alignment and speech clipper adjustments
16	6625-99-949-1999 OR 6625-99-943-1524	Multimeter set, Avo, type 9SX (CT498)	Power supply checks, d.c. levels, setting up and realignment
17	10S/9490872 6625-99-949-0872	Multimeter, Avo, model 8S	Testing semi-conductors during fault diagnosis and repair
18	6625-99-200-2271	Test set, transistor, CT446	Seal testing checks after repair
19	6625-99-942-4825	Leak locator CT509	Drying out equipment after repair but before resealing
		Over, drying, telecommunication equipment	

CURRENT CONSUMPTION

45. The current consumption must not exceed the values shown in Table 4. The figures of current and voltage can be obtained from the instruments fitted in the Kits testing A43R Mk 2.

Table 4 - A43R current consumption

A43 System switch	Input voltage	Input current (Max)
PHONE - Receive	12V	0.25A
PHONE - Transmit	11.5V	3.2A
BEACON CW	11.5V	3.0A
BEACON TONE	11.5V	3.75A

TRANSMITTER TESTS

Frequency accuracy

46. a. Specification: Better than $\pm 0.001\%$ of the channel frequency ie better than $\pm 2.4\text{kc/s}$ at 240Mc/s and $\pm 3\text{kc/s}$ at 300Mc/s .
- b. Method:
- (1) Connect the test equipment as detailed in Fig 1 with the counter in position.
 - (2) Set the stabilized power supply to 11.5V.
 - (3) Switch A43R system switch (SA) to PHONE and the CHANNEL switch to the channel being tested.
 - (4) Kit Testing A43R BATTERY LOAD TEST switch to OFF, put the PRESSEL switch to ON, PHONE switch to OFF and MIC switch to OFF.
 - (5) Adjust the counter to read the transmitted frequency. Check that the error does not exceed $\pm 0.001\%$ of channel frequency.

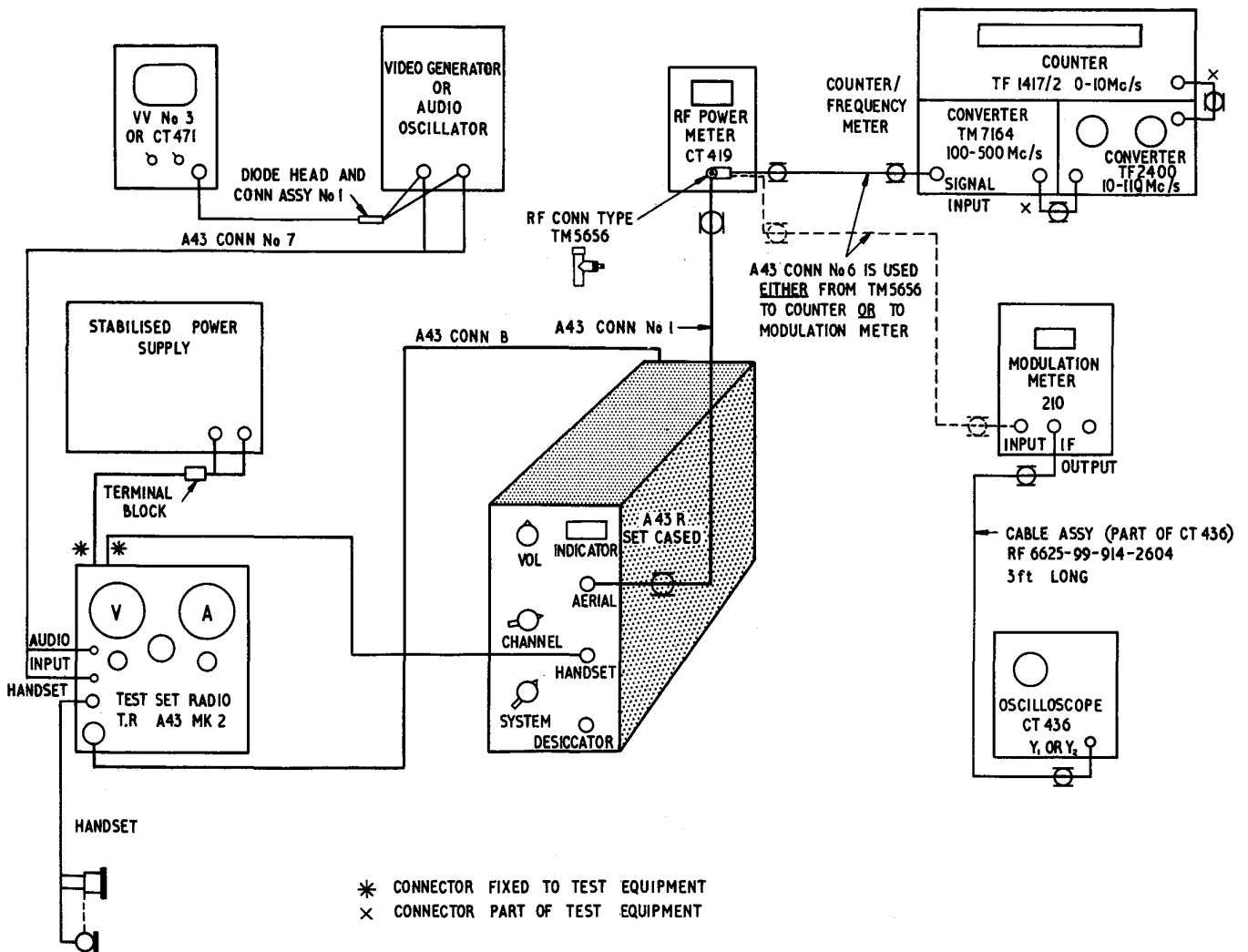

1380/69

Fig 1 - Transmitter performance specification, test layout (set cased)

R.F. power output

47. a. Specification: The power delivered into a 50Ω resistive load connected to the antenna plug at any channel frequency and emission will not be less than 2W.
- b. Method: (1) Proceed as detailed in para 48 b. (1) to (4).

- (2) Check that the power output on each channel is not less than 2W on all types of emission.
- (3) Set the input supply to 11V.
- (4) Check that the power output on the lowest and highest frequencies is not less than 2W.
- (5) Typical figures to be expected from a serviceable transmitter after repair are as follows:

240Mc/s			
"	PHONE	=	3.5W (2.5W)
"	BEACON CW	=	2.5W (2.5W)
"	BEACON TONE	=	4W (3.4W)
300Mc/s	PHONE	=	2.75W (2.7W)
"	BEACON CW	=	3.5W (2.7W)
"	BEACON TONE	=	4.25W (3.5W)

Note: the output from the modified A43R Mk 2 (para 35) is lower and is given in parenthesis.

Modulation percentage and speech clipping efficiency

48. a. Specification: The output produced with an initial a.f. level of 750mV at 1000c/s must not be increased by more than 25% when the a.f. level is increased four times and is to be just symmetrically clipping.
- b. Method:
 - (1) Disconnect the counter and convertors from the r.f. connector TM5656 and connect the modulation meter (Airmec 210) in their place.
 - (2) Connect the audio signal generator (high impedance) to the input MIC terminals of the Test Set Radio A43R Mk 2. Adjust the audio frequency to 1000c/s and an output of 750mV as measured by a valve voltmeter at the signal generator output.
 - (3) Connect the Oscilloscope CT436 Y1 amplifier input to the i.f. socket of the modulation meter. Put the MIC switch of the test set radio to ON.
 - (4) Tune the modulation meter to the appropriate channel frequency of the A43R (normally channel 1, 251.2Mc/s). Monitor the output on the oscilloscope and adjust the display to a height of 2 cms.
 - (5) Check that the modulation for an input of 750mV is approximately 30% when measured on the modulation meter.
 - (6) Increase the audio input to 1.8V and check that the modulation is between 90% and 100%.

(7) Increase the audio input to 3V, the amplitude of the envelope displayed on the oscilloscope is not to exceed 25% of the original 2 cm display and is to be just symmetrically clipping.

Beacon tone frequency

49. a. Specification: The frequency of the BEACON TONE must be between 700c/s and 1000c/s.
- b. Method:
- (1) With the equipment set up as in para 50, connect the audio signal generator to the oscilloscope Y2 amplifier.
 - (2) Put the A43R SYSTEM switch to BEACON TONE.
 - (3) Adjust the audio signal generator frequency until the Y1 and Y2 displays indicate the same frequency. This is to be between 700c/s and 1000c/s.

Condition indicator

50. a. Specification: Increase of speech input to microphone produces an increase in illumination.
- b. Method:
- (1) Reconnect the audio signal generator to the MIC terminals of the Test set radio and switch the A43R to PHONE.
 - (2) Vary the audio input level about 1V at 750c/s and note that the illumination of the indicator increases and decreases in agreement with the variation of input level.

Receive to transmit delay time

51. a. Specification: The time required for a transmitter to reach 2W output, with an input supply of 11V, must not exceed 4 sec (EMER Tels F 537 Mod 2 completed).
Note: The later models mentioned in para 35 have a limit of 1.5 sec.
- b. Method:
- (1) Connect the modulation meter and oscilloscope as detailed in para 50.
 - (2) Set the input supply to the A43R to 11V.
 - (3) Put the A43R SYSTEM switch to PHONE and connect a handset directly to the HANDSET socket on the front panel.
 - (4) Depress the pressel switch and check that the r.f. output is at least 2W. Tune the modulation meter to the A43R and adjust the oscilloscope display to represent 0.5W/cm. deflection. Release the pressel switch.

(5) Using a stop watch, check that on operating the pressel switch, the time taken for the r.f. output to reach 2W is less than 4 sec or 1.5 sec in the case of the later models. The measurements should be taken observing the oscilloscope display as the r.f. power meter has a time lag.

(6) In Base workshops this test can be checked electronically in the following manner:

Connect the test equipment as shown in Fig 5 and set up the equipment as detailed in para 53 b. (1)-(3).

(a) Connect the frequency counter START B input to TP307 using the A43R connector No 3 and No 4 joined together at the unterminated ends. One Oxley plug is now inserted into TP307 and the other plug into the inner portion of the co-axial socket of the counter START B. Connect the counter STOP C input to TP310 and chassis earth using the A43R connector No 2.

(b) Set the frequency counter controls as follows:

FUNCTION	to	TIME B-C
FREQ. TIME	to	1/100 sec
DISPLAY		Pointer vertical
START B		Slope -ve; trigger level attenuators both to 5.
STOP C		Slope -ve; trigger level attenuators both to 5.
INPUT A		Not used
GATE		AUTO

(c) Connect the A43R to the test set radio and connect the handset directly to the A43R. Set the test set switches as follows: MIC to ON, PHONE to ON PRESSEL to OFF and the BATTERY LOAD to OFF.

(d) Adjust the input supply to 11V d.c. on load (transmit).

(e) Put the A43R SYSTEM switch to PHONE.

(f) Operate the A43R pressel switch and check that the r.f. power meter (CT419) indicates a minimum of 2W.

(g) With the pressel switch still operated tune the modulation meter to the channel frequency selected. Adjust the oscilloscope (CT436) to give a display equal to 0.5W/cm deflection.

(h) Operate the pressel switch and check that the counter starts and stops counting over a period coincident with the rise of r.f. power indicated on the oscilloscope.

Note: The STOP C variable attenuator may require slight adjustment to produce the correct STOP timing, ie at the period of peak r.f. power displayed on the oscilloscope. Do not advance the DISPLAY control to the point where cancellation affects the count.

(j) Take three separate counts of the elapsed time between operation of the pressel switch and r.f. output of 2W. Allow a period of 3 min. between each count. The average must be not greater than 4 sec or 1.5 sec as applicable.

RECEIVER TESTS

Sensitivity/signal to noise ratio/automatic gain control

52. a. Specification: A signal of $5\mu\text{V}$ modulated 30% at 1000c/s is to produce not less than 2mW a.f. with a signal-to-noise ratio better than 10dB. An increase of input signal by 60dB above $5\mu\text{V}$ is to produce a change of less than 6dB in output.

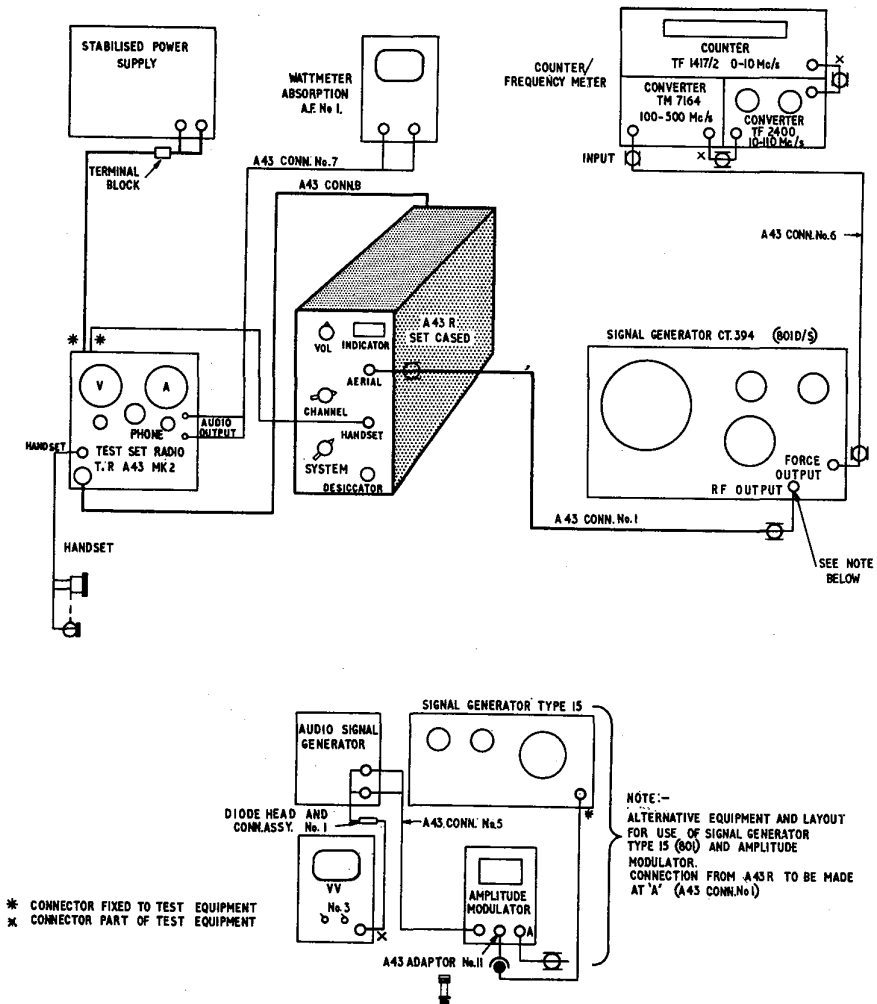

Fig 2 - Receiver performance specification, test layout (set cased)

- b. Method:
- (1) Connect the test equipment as shown in Fig 2 and put the A43R SYSTEM switch to PHONE.
 - (2) Adjust the stabilized power supply to 12V.
 - (3) Put the test set switches as follows:
LOAD to OFF, PRESSEL to OFF, MIC to OFF and PHONE to ON.
 - (4) Switch the Wattmeter, AF, No 1 (CT44) to 300Ω impedance and set the power range to 6mW.
 - (5) Set the signal generator to the channel frequency under test, signal output to 5mV modulated 30% at 1000c/s.
 - (6) Set volume control fully clockwise.
 - (7) Check that the a.f. output is not less than 2mW.
 - (8) Adjust the volume control until the a.f. output is 2mW. Switch off the modulation and check that the output is at least 10dB down.
 - (9) Switch on the modulation. Increase the signal input to 5mV (60dB). Check that the output does not exceed 8mW. This test is only to be carried out at the lowest and highest channel frequencies.

Image rejection

(Second channel selectivity)

53. a. Specification: At a frequency of 38.1Mc/s below the channel frequency the signal input is to be at least 50dB up on the sensitivity input specification.
- b. Method:
- (1) Proceed as detailed in para 54 b. (1) to (5), select the lowest channel frequency.
 - (2) Adjust the volume control to give 2mW output.
 - (3) Reduce the signal generator frequency by 38.1Mc/s and increase the input to 1.6mV (50dB).
 - (4) Tune the signal generator for maximum reading on the Wattmeter, AF, No 1. The output is not to be greater than 2mW.

1st Oscillator/oscillator multipliers frequency accuracy

54. a. Specification: The multiplied oscillator output frequency is to be better than $f_s - 19.05\text{Mc/s} \pm 0.001\%$.

Note: For this and subsequent checks the A43R must be removed from its case.

b. Method: (1) The frequency is measured at TP103 where the signal is $\frac{fs-19.05Mc/s}{4}$

On Channel 1 the radiated frequency is 251.2Mc/s therefore the frequency at TP103 is to be 58.0375Mc/s \pm 580c/s.

(2) Connect the test equipment as detailed in Fig 3 and put the A43R SYSTEM switch to PHONE and the CHANNEL switch to the channel under test.

(3) Adjust the stabilized power supply to 12V.

(4) Connect the frequency counter to TP103 via a 0.05 μ F capacitor

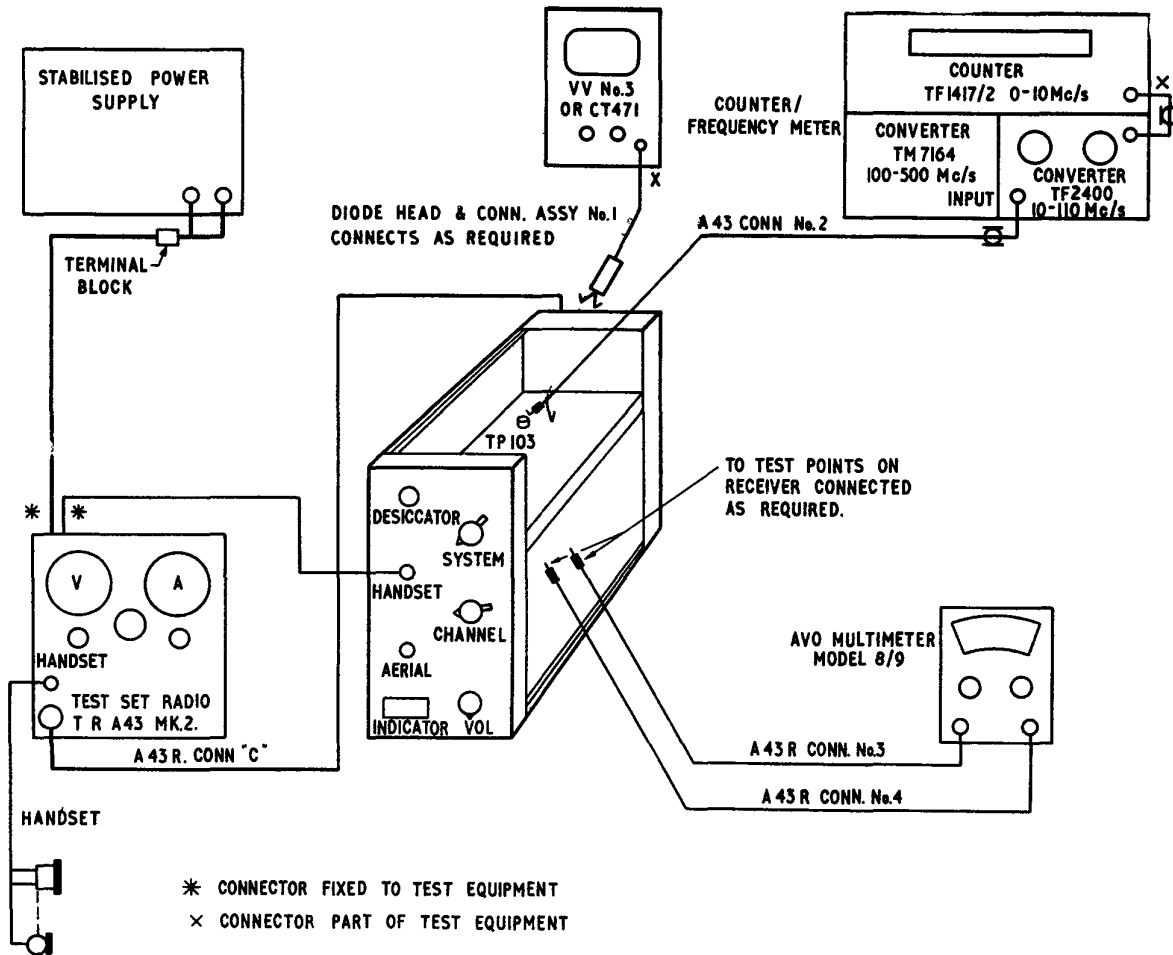

1380/80

Fig 3 - Receiver 1st oscillator/multiplier stages, specification test layout (set open)

(5) Check that the frequency error for each channel does not exceed $\pm 0.001\%$. It is important that the circuit be allowed to settle and the frequency counter indications averaged over six counts.

2nd Oscillator frequency accuracy and output

55. a. Specification: The frequency accuracy is to be better than 19.980Mc/s ± 50 c/s and the output level is to be not less than 80mV.
- b. Method: (1) Connect the test equipment as detailed in para 54 Sub paras 2 and 3
(2) Connect the frequency counter between pin 1 of the 2nd oscillator stage and chassis using the Cable assembly, r.f. (6625-99-914-2604) which is issued with the Oscilloscope set CT436. Check that the frequency is 19.980Mc/s ± 50 c/s and the output voltage, as measured by a valve voltmeter must be not less than 80mV.

Battery Charger tests

56. a. Specification: (1) With the input supply varied over the voltage ranges 11V to 16V and 22V to 30V the output voltage is to be 13.2 \pm 100mV (Magnatex lead acid battery) or 14.6 \pm 100mV (NIFE nickel cadmium battery).
- (2) The meter calibration mark is 25mA \pm 5mA (Magnatex) or 150mA \pm 25mA (NIFE).
- (3) The indicator lamp is to light only when the input polarity is correct.
- b. Method: (1) Connect the battery charger to the stabilized power supply set to 14V.
- (2) Connect the output to a lamp load capable of carrying 0.5 to 1A.
- (3) Check that the indicator lamp lights and that the output voltage is 13.2 \pm 100mV (Magnatex) or 14.6 \pm 100mV (NIFE).
- (4) Vary the input voltage over the ranges 11V to 16V and 22V to 30V. Check that the output voltage remains within specification.
- Note: The relays automatically changeover when the input voltage is increased to 22V but the input supply must be switched off when changing over from a higher to a lower voltage to allow the relays to release.
- (5) Disconnect the lamp load and connect a 500 Ω 1/2W resistor (Magnatex) or 100 Ω 3W resistor (NIFE) in series with the multimeter set to d.c. current, across the output terminals. Check that when the load current is 25mA \pm 5mA

or 150mA±2mA that the battery charger meter pointer is on the calibration mark between the red and blue sections of the **scale.**

(6) Reverse the input supply polarity. Check that the indicator lamp does not light and the input current is less than 10mA.

Battery adaptor tests

57. a. Specification: Relay is only energised when the input supply is of the correct polarity.
- b. Method: (1) With the millimeter check that there is an open circuit between PLA-B and PLB negative.
- (2) Energise RLA/4 by connecting 12V d.c. to PLB (observe correct polarity).
- (3) Check that there are 12V between pin A and pin B of PLA.
- (4) Reverse the polarity of the input to PLB and check that there is no voltage between the pins of PLA.
- (5) Disconnect the 12V supply and check that there is no connection between the pins of PLA and PLB and the case.

A43R battery tests

(Magnatex lead acid or NIFE nickel cadmium)

58. a. Specification: (1) Voltage fully charged (off load): 12-13V d.c. nominal.
- (2) Duration of discharge: Approximately two hours at 3:1 receive/transmit ratio.
- b. Method: (1) Attach the battery to the battery charger and leave until the indicator shows the battery to be fully charged.
- (2) Connect the battery to the Test set radio, A43R, using connector A. Operate the BATTERY LOAD TEST switch to the 42W setting for a period of five minutes and at the end, check that the voltage indicated while still under load is not less than 11.5V. Unless this output voltage is maintained, the battery must either require further charging, or is defective.
- (3) Proceed with the duration of the discharge test by operating the BATTERY LOAD TEST switch on the basis of one minute period at 42W transmit and three minutes at 4W receive for a two hour period. After two hours the voltage of the battery must be not less than 11V.

A43R whip (tape) antenna

59. a. Specification: (1) There shall be continuity between the centre of the co-axial connector and the end of the antenna element.
- (2) The insulation between the centre of the co-axial connector and the outer part of the connector shall be not less than 100k Ω .
- b. Method: (1) Connect the test prods of the Tester, insulation No 3 (or No 4) on the low ohms range, between the inner co-axial plug and the looped end of the metal tape element. Check for continuity.
- (2) Connect the test prods of the Tester insulation No 3 (or No 4) between the inner and outer parts of the antenna co-axial connector. With the tester on the insulation range, check that the insulation resistance of the antenna is within the specification.

A43R discone antenna

60. a. Specification: (1) There shall be continuity between the centre of the co-axial connector and the ends of the discone antenna elements.
- (2) The insulation between the centre of the co-axial connector and the outer part of the connector shall be not less than 100k Ω .
- (3) The capacity of the antenna in an open condition shall be between 9-12pF. The power factor shall be less than 0.005.
- b. Method: (1) Connect the test prods of the Tester insulation No 3 (or No 4), on the low ohms range, between the inner co-axial plug and the ends of the metal tape elements. Check for continuity.
- (2) Connect the test prods of the Tester insulation No 3 (or No 4) between the inner part of the co-axial connector of the antenna and the outer part of the connector. With the tester on the insulation range check that the insulation resistance of the antenna is within specification.
- (3) (a) Connect the A43R connector No 5 to the co-axial socket of the discone antenna.
- (b) Connect a Wayne Kerr universal bridge type B221 to the spade ends of the A43R connector No 5.
- (c) Stand the antenna in an open condition on the four long radials.

(e) Remove the antenna and measure the capacity of the A43R connector No 5.

(f) From measurements (d) and (e) deduce the capacity of the antenna above by subtraction. The limit is to be $10.5\text{pF} \pm 1.5\text{pF}$.

(g) Note the power factor which must be less than 0.005.

Cable assembly r.f.
(Z1/5820-99-949-1302)

61. a. Specification: (1) There shall be continuity between the ends of the cable assembly for both inner and outer conductors. The length overall must be approximately 20 ft.
- (2) The insulation resistance between the inner and outer conductors must be not less than $100\text{k}\Omega$.
- b. Method: (1) Connect the test prods of the Testers insulation No 3 (or No 4) on the low ohms range between the inner part of the discone end (co-axial plug) and the inner part of the antenna socket end of the Cable assembly, r.f. Check for continuity.
- (2) Connect the test prods of the Tester insulation No 3 (or No 4) between the inner part of the antenna plug co-axial connector and the outer part of the connector. With the tester set to the insulation range, check that the insulation resistance of the antenna is within specification.

ELECTRICAL ADJUSTMENTS AND ALIGNMENT

GENERAL

62. a. The adjustments and alignment detailed in this section are carried out to achieve the set performance in the specification test section.
- b. The A43R i.f. amplifier trimming tool, Fig 4008 has been designed to allow the following tasks to be carried out:
- (1) The slotted end across the hexagonal section is made to fit the the core adjusters of the 930kc/s i.f. amplifiers.

(2) The hexagonal section is made to fit the core adjusters of the 19.05Mc/s i.f. amplifiers.

(3) The slot in the round section provides an effective method of adjusting the coupling of L309 to the power amplifier V306 anode circuit, L307.

c. The A43R turret trimming tool, Fig 4007, has been designed to adjust the preset capacitors fitted to the tuners radio frequency. The metal end is to be used for normal circuit alignment of the trimmers, with the non-metallic end as an alternative for adjustment when hand capacity occurs. **Care must be taken whilst removing Tuners r.f. (biscuits) from the turret drum and for this purpose, a biscuit removing tool (Fig 4009) must be used.**

d. Crystals and capacitors mounted on the biscuits are underlined when referred to in the text eg "XL301 is trimmed by C302".

TRANSMITTER

Frequency and r.f. power output

63. Method:

- a. Connect the test equipment as detailed in Fig 4.
- b. Set the stabilized power supply to 11.5V.
- c. Switch the A43R SYSTEM switch to PHONE and the CHANNEL switch to the appropriate channel. If complete alignment is to be carried out switch initially to the highest frequency channel.
- d. On the Test set radio A43 Mk II put the BATTERY LOAD TEST switch to OFF, the PRESSEL switch to ON, MIC switch to OFF and the PHONE switch to OFF.

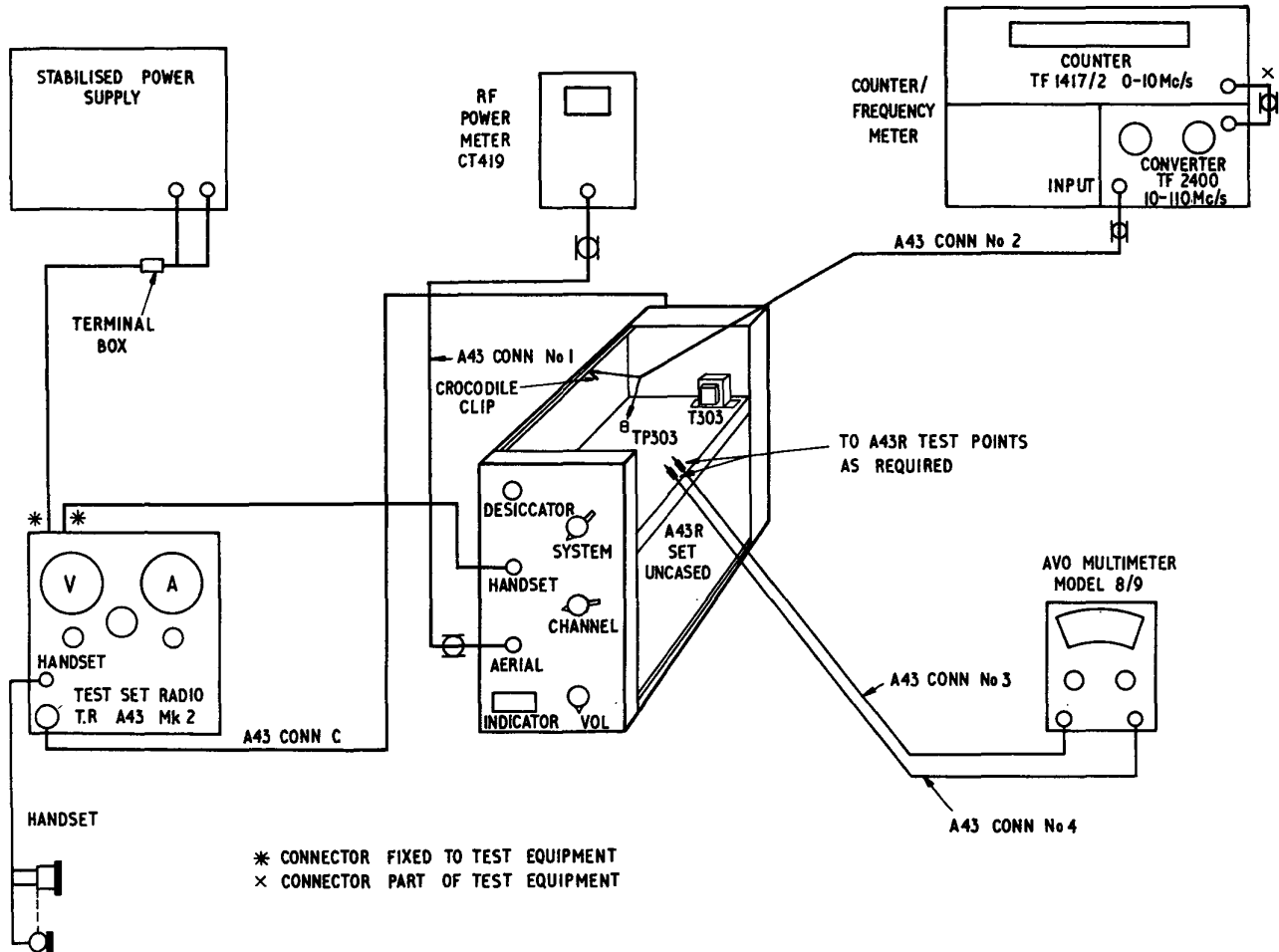

Fig 4 - Transmitter alignment, test layout

Frequency

64. a. Adjust the crystal trimmer C302a until the counter indicates the channel frequency ± 4 to within $\pm 20c/s$ of nominal, the accuracy is to be maintained for six consecutive counts. If after the replacement or repair of a crystal channel tuner, the oscillator cannot be pulled into frequency by the adjustment of C302a, withdraw the channel tuner and check whether the link connecting C301a is in circuit. It may be necessary to remove or replace the link. The capacitor C301a is never to be removed except when it is unserviceable.

b. If the frequency output drifts, a very slight adjustment of V301 anode trimmer C307a may be necessary to bring the stage on to the correct frequency and adjust stability. It is then necessary to readjust the crystal trimmer C302a for the correct frequency as indicated on the counter.

c. When the adjustment to maintain frequency stability is carried out, the adjustment in para 67 b. must be omitted.

R.F. power output

65. The trimmers C324 (V305 grid), C341 and L308 (series tuning and output coupling link) which are situated on the fixed transmitter deck should not normally require adjustment unless components or valves have been changed. The procedure detailed below is for the complete alignment, if only one or two channels require alignment it may only be necessary to carry out the adjustments in sub-para 1.:-

a. Switch to the highest frequency channel.

b. V301 oscillator doubler: Connect the positive lead of the multimeter, set to 1mA d.c. range, to TP307 and the negative lead to TP302. Adjust V301 anode trimmer capacity C307 for maximum deflection. A typical reading would be 25 μ A.

c. V302 doubler: Transfer the multimeter negative lead to TP303. Adjust V302 anode trimmer C313 for maximum deflection. Typical reading, 0.31mA.

d. V303 doubler: Adjust multimeter range switch to 10mA d.c. and transfer the negative lead to TP304. Adjust V303 anode trimmer C322 for maximum deflection. Typical reading 1.6mA.

e. V304/V305 doubler: Transfer the multimeter positive lead to TP305 and the negative lead to TP306. Note reading (typical 1.8mA). Transfer the negative lead to TP308 and again note the reading. If the two readings differ by more than 0.1mA, adjust C324 slightly. Repeat c. and d. and note the readings obtained from TP306 and TP308. Repeat until the difference falls below 0.1mA.

f. V304/V305 doubler anode: Transfer the multimeter positive lead to TP310 and the negative to TP309. Adjust V304 and V305 anode trimmer C328 and V306 grid trimmer C330 for maximum deflection of meter. It will be necessary to repeat these adjustments several times since, due to the tight coupling, movement of one trimmer will affect the setting of another. Typical readings are 3.5mA at 300Mc/s and 5.0mA at 240Mc/s.

g. Switch to lowest frequency channel and repeat b. c. d. and f. Switch to the highest frequency channel.

h. V306 power amplifier: Adjust V306 anode trimmers C333 and C335 for maximum power output.

j. Adjust C341, series tuning the output coupling link, and adjust the position of the coupling link, L308, for maximum output.

k. Switch to the lowest frequency channel and repeat h. and j. Repeat these adjustments several times at highest and lowest channel frequencies for optimum performance. If a new PA tank coil L307 is fitted it may require adjustment to cover the band.

l. Switch to the other channels requiring alignment and carry out the adjustments detailed in b. c. d. f. and h. for maximum power.

Transmitter modulator clipper stages

66. a. With the A43R Mk 2 connected as detailed in Fig 5 and an input level of 3V at 1000c/s, check that the waveform displayed on the oscilloscope is symmetrical.

b. If the waveform is not symmetrical adjust RV201 and RV202 to mid position.

c. Recheck and if necessary adjust RV201 and RV202 until the waveform is just clipping symmetrically.

Condition indicator

67. a. With the A43R connected to the test set radio as detailed in para 52 remove channel 2 transmitter tuners from the turret.

b. Put the CHANNEL switch to channel 2. Care must be exercised to prevent damage to turret stator contacts.

c. Switch the SYSTEM switch to PHONE and operate the PRESSEL switch on the test set.

d. Check that the DM70 (V201) output indicator has only the dot illuminated when the CHANNEL switch is set to channel 2, (a position without a tuning unit). After checking put the PRESSEL switch to OFF.

e. Select the highest available frequency, nearest to 300Mc/s. Put the PRESSEL switch to ON.

f. With the slotted end of the i.f. trimming tool adjust L309 to produce a half length illumination of DM70 (V201). Put PRESSEL switch to OFF.

g. Select the lowest available frequency nearest to 240Mc/s and put the PRESSEL switch to ON. Check the illumination of DM70 (V201) at this frequency.

h. If necessary adjust L309 to give approximately equal illumination at the lowest and highest frequencies.

j. Check that the condition indicator operates satisfactorily on the other channels.

k. Replace the channel 2 transmitter tuners and recheck the transmitter output on this channel.

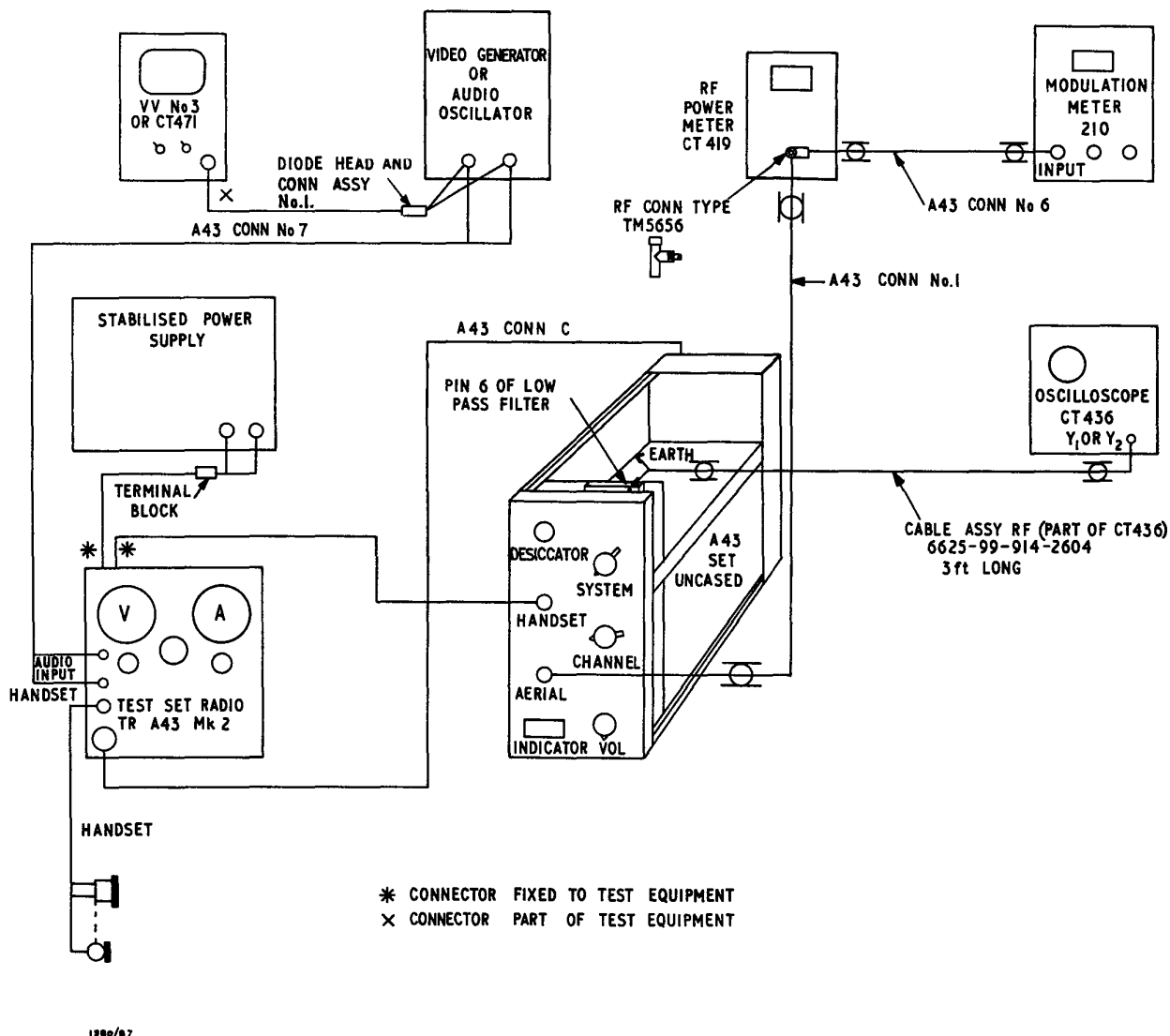

Fig 5 - Transmitter speech clipper/beacon tone, test layout

RECEIVER

2nd oscillator

68. a. Connect the test equipment as detailed in para 57.
- b. Adjust C163 in the 2nd oscillator stage until the frequency is 19.980Mc/s ± 50 c/s for at least six consecutive counts.
- c. Check that the output measured on the Multimeter electronic CT471 is at least 80mV. If this is not so, adjust T107 for maximum deflection.

- d. Recheck the oscillator frequency and adjust if necessary.

I.F. amplifiers

General

69. a. The i.f. amplifiers have been encapsulated during manufacture and are designed for a high degree of stability. Adjustment of the trimmers is extremely difficult due to the sealing.
- b. Repair action and/or realignment of an i.f. amplifier stage will only be carried out if it is not possible to meet overall specification figures by r.f. alignment/repair.
- c. Typical stage gains are given in para 83. It will be found that variations of these figures occur due to differing transistor characteristics.
- d. Replacement stages when received from stores will be aligned to the manufacturers production specification but with the i.f. tuning adjusters unsealed.
- e. External damping circuitry cannot be used due to encapsulation. Point to point alignment will be confined to the faulty stage being replaced/realigned as it is extremely difficult to obtain the correct i.f. response without wobulation.
- f. Realignment by wobulation methods is described in para 76 and this method will normally be used during base repairs.

2nd i.f. amplifier

70. a. Connect the test equipment as detailed in Fig 6.
- b. The Signal generator No 12 is tuned to 930kc/s on c.w. and the cursor adjusted with the Counter, frequency, meter TF/1417/2. Apply amplitude modulation at 1000c/s, 30% depth and output level of 30 μ V. Connect the output of the signal generator via Units, terminating, r.f. No 3 (using the 75 Ω X1 and E terminals) to pin 6 of the second mixer via a 0.1 μ F capacitor. The earth terminal to be connected to the nearest chassis earth.
- c. Set the stabilised power supply to give 12V d.c. and the switches of the Test set radio A43R as follows:- BATTERY LOAD TEST to OFF, PRESSEL to OFF, MIC to OFF, the PHONE switch to ON to identify the signal generator input and then to OFF when readings are being taken.
- d. Set the A43R SYSTEM switch to PHONE, the CHANNEL switch to 1 and the VOLUME control fully clockwise.
- e. Connect the Multimeter electronic CT471 between pin 1 of the detector stage and chassis.

f. Adjust the cores of the i.f. stage replaced for maximum reading on the multimeter. The cores must then be sealed with Dulux, red, varnish insulating, anti-tracking, air drying (H1/8019-99-942-8917).

g. Tune the signal generator through 930kc/s for a peak and check that the frequency is 930kc/s \pm 12kc/s.

1st i.f. amplifier

71. a. Connect the test equipment as detailed in Fig 6.

b. Check the 19.050Mc/s calibration of the Signal generator No 18 on c.w. against the frequency counter, then adjust the amplitude modulation to 1000c/s 30% depth and output level 10 μ V (75 Ω).

c. Connect the output lead of the signal generator via Connector, twin, No 423, 7 in. long and then via a 0.1 μ F capacitor to the 1st mixer emitter (VT103). Connect the earth lead to the nearest chassis earth.

d. Set the controls and equipment as detailed in para 72 c. d. and e.

e. Adjust the cores of the i.f. stages for maximum reading on the Multi-meter electronic CT471 and then seal as detailed in 72 f.

f. The reading obtained in e. must exceed 250mV with an input of 10 μ V.

g. Check that the overall i.f. bandwidth is between 55 and 60kc/s at 6dB down and that it is less than 200kc/s at 60dB down.

h. A typical overall response curve is shown in Fig 7.

72. I.F. amplifier response curve by wobble
(Base repairs)

a. Connect the test equipment as detailed in Fig 8.

b. Set the stabilized power supply to 12V d.c. Put the switches of the Test set radio to the following positions:- BATTERY LOAD TEST to OFF, MIC to OFF and the PHONE switch to ON to identify the signal during setting up. The output lead from pin 1 of the detector stage is disconnected when actual response measurements are made.

c. Put the A43R SYSTEM switch to PHONE, the CHANNEL switch to 1 and the VOLUME control fully clockwise.

d. Connect the output lead of the Signal generator No 18 to the 1st mixer emitter (VT103) via Connector, twin No 423, 7 in. long and a 0.1 μ F capacitor. The earth connection is to be made to the nearest chassis earth point.

e. Connect the oscilloscope (CT436) Y2 input to pin 1 of the A43R detector stage and shunt this connection with a 68k Ω resistor (composition type) in parallel with a 0.01 μ F capacitor to chassis. The oscilloscope earth to be made to the nearest chassis earth point.

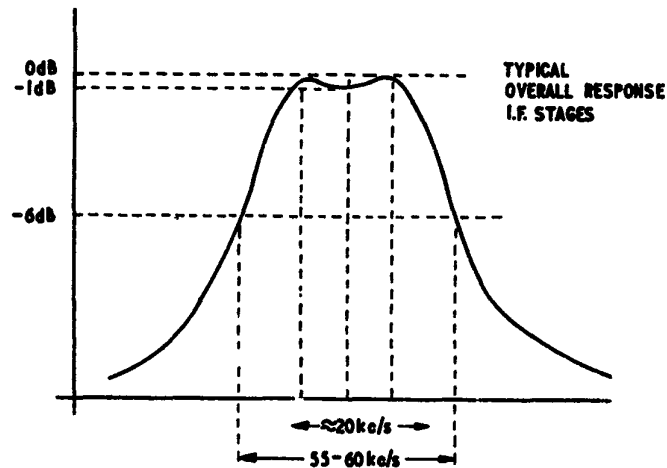

480/75

Fig 7 - Typical overall response, i.f. stages

f. A theoretical diagram of a suitable 50c/s sweep source for external modulation of the Signal generator No 18 is given in Fig 4005. RV1 controls the phase adjustment (BLANKING) to the 'Z' modulation input of the CT436. RV2 controls the amplitude of the sweep to the external modulation of the signal generator. RV3 controls the 50c/s sweep voltage to the 'X' input of the CT436.

g. Connect the output of the sweep source to the oscilloscope and signal generator.

h. Switch on the signal generator and set up as follows:

DEVIATION, NORMAL, 75kc/s
MODULATION SELECTOR, F.M. EXT. MCD
FREQUENCY RANGE, 13.5Mc/s-27Mc/s
TUNE CONTROL 19.050Mc/s
INCREMENTAL Zero
OUTPUT VOLTAGE 100 μ V MULTIPLY by 4.0

Switch on the oscilloscope and set up as follows:

Y2 to DC
V/cm 1
Time/cm 100 ms EXT

Switch on the sweep source and adjust the controls as follows:

Adjust the X input to mid-position and observe if the trace appears on the screen of the oscilloscope. Adjust the external modulation voltage to the signal generator until the response appears on the screen (the

mid point will do for an initial setting). During the setting up, the signal can be heard in the headset and will assist in correctly tuning the signal generator. Adjust the modulation voltage until a display height of 1.5 in. is obtained and is centrally presented. Disconnect the screened lead when the best results have been obtained and adjust the blanking control until the secondary image is removed (the brightness control may require adjustment as well).

j. In order that the central frequency can be identified an additional marker signal from another signal generator to the modulation layout is required. An unmodulated accurately calibrated 19.050Mc/s signal is fed to pin 6 of the detector stage and the level adjusted to provide a calibration. A typical response curve is shown in Fig 7.

k. The deviation points on either side of the centre frequency can be established and marked on the trace by changing the marker frequency by incremental adjustment.

Mechanical adjustment of i.f. amplifier trimmers

73. a. The use of the A43R i.f. amplifier trimming tool permits i.f. tuning adjustments to be made on both i.f. amplifiers with the A43R receiver deck in the operational position.
- b. To release the 930kc/s slotted i.f. tuning adjusters a 3 in. length of 0.1 in. dia. metal rod with a slotted end (the slot to be 0.025 in. wide across the centre of one end and is 0.075 in. deep) is used as a thermal conductor to release the sealing compound.
- c. The slotted end of the metal rod is warmed by first laying it across the bit of an electric soldering iron and then placing it against the i.f. tuning adjuster. After 30 secs remove the metal rod and immediately fit the A43R i.f. amplifier trimming tool to the i.f. tuning adjuster. Carefully rotate the adjuster back and forth on its thread to release the sealing compound.
- d. The tuning adjusters fitted to the 19.050Mc/s i.f. amplifiers are moved as required by careful rotation of the A43R i.f. amplifier trimming tool hexagonal section when it is fitted to the core.

I.F. amplifier alignment by modulation

74. With the equipment connected as shown in Fig 8 adjust each stage, starting with the detector. Trim it to give a flat topped or slightly double humped response at the detector, centred on the marker. The overall response must be within the specification limits.

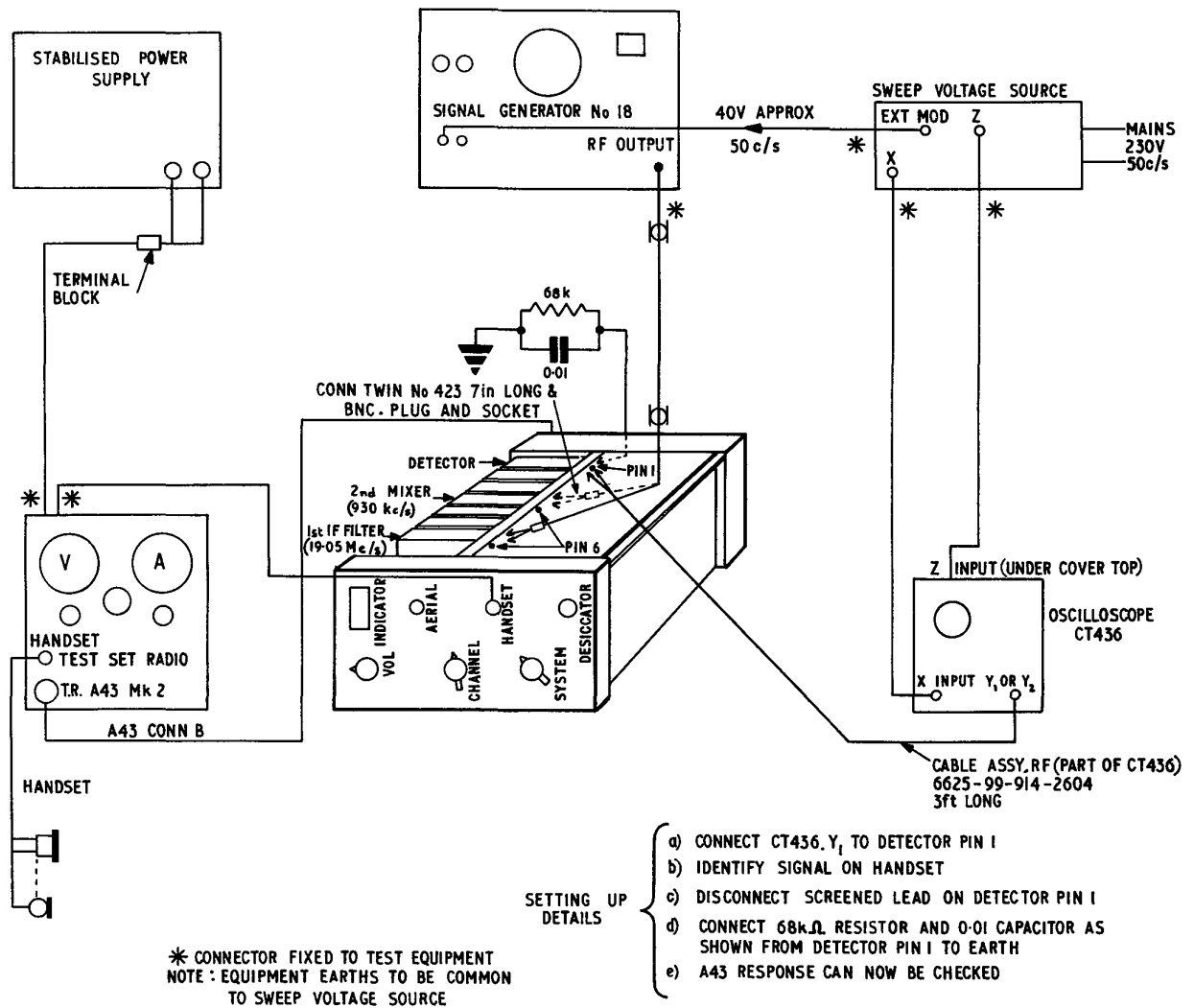

Fig 6 - Receiver i.f. alignment, modulation test layout

b. Rescale the 930kc/s and 19.050Mc/s i.f. tuning adjusters with Dulux red, varnish insulating, anti-tracking, air drying (H1/8010-99-942-8917).

1st oscillator/oscillator multiplying stages

75. a. Connect the test equipment as shown in Fig 3.

b. Adjust the stabilized power supply to 12V d.c. and the test set radio switches as follows:

BATTERY LOAD TEST to OFF, IIC to OFF PHONE to ON. Put the A43R SYSTEM switch to PHONE and CHANNEL switch to the channel to be aligned.

- c. Carry out the initial setting up as follows:-
- (1) Connect the positive lead of the multimeter, set to 10mA, to TP102 and the negative lead to TP106. Adjust C148a for maximum deflection, the meter reading must be approximately 1.3-1.6mA. After the test disconnect the positive lead.
 - (2) Set the multimeter to 10V d.c. range and connect the positive lead to TP103. Adjust C150a for maximum deflection, the meter reading must be 2.2-2.5V.
 - (3) Transfer the positive lead to TP104. Adjust C153a for maximum deflection, the meter reading must be 2.2-2.5V.
 - (4) Transfer the positive lead to TP105. Adjust C156a for maximum deflection, the meter reading must be 4 - 6V.
 - (5) If the current specified cannot be obtained, check other channels. For correct operation of the mixer stage the figure given in (4) must be obtained.
- d. Connect the frequency counter (TF1417/2) together with a 10-100Mc/s converter (TF2400) to TP102 using the A43R connector No 2. The earth connection is to be made to the nearest chassis point. The frequency measured is twice the crystal frequency, i.e. $\frac{fs-19.05Mc/s}{8}$. Adjust C148a until the frequency is accurate to within $\pm 20c/s$ for six consecutive counts.
- e. If, after the replacement or repair of a crystal channel tuner, the oscillator cannot be pulled into frequency by the adjustment of C148a, withdraw the channel tuner and check whether the link connecting C147a is in circuit (Tels F 532 Part 1, para 64 refers). It may be necessary to either remove or replace the link. The capacitor C147a itself is never to be removed except when it is unserviceable and being replaced.
- f. If the oscillator drifts in either a positive or negative direction it is necessary to slightly adjust C150a and C148a alternately for a stable result.
- g. Final adjustment of the other 1st oscillator multiplier stages (VT109) C153a, (VT110) C156a and (VT111 and VT112) C161a are carried out during r.f. alignment for optimum performance.

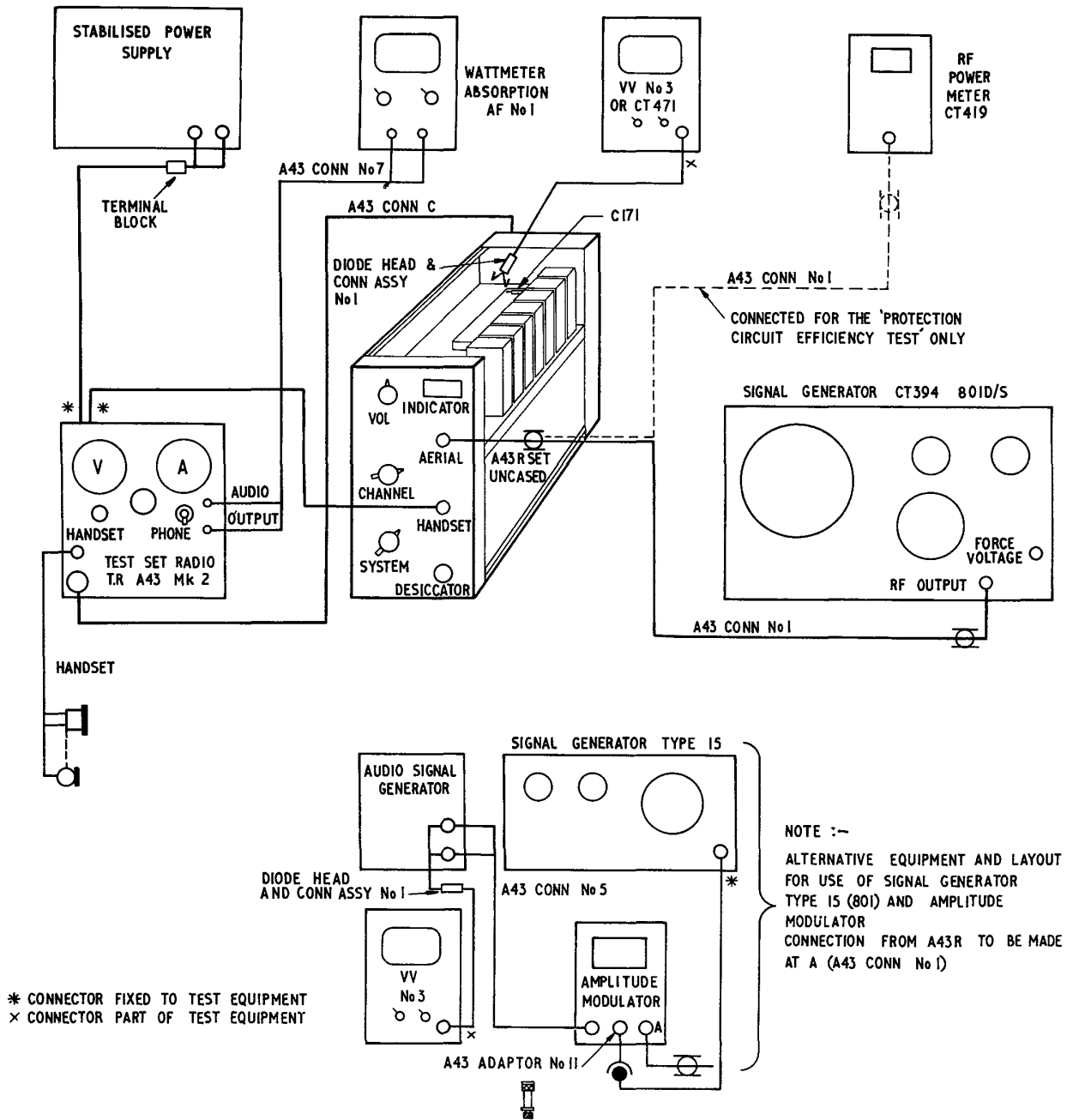

1980/81

Fig 9 - Receiver r.f. alignment, test layout

R.P. alignment

76. a. Connect the test equipment as shown in Fig 9.

b. Adjust the stabilized power supply to 12V d.c. and the test set radio switches as follows:- BATTERY LOAD TEST to OFF, MIC to OFF and PHONE to ON.

Put the A43R SYSTEM switch to PHONE and the CHANNEL switch to the channel to be aligned.

- c. Tune the signal generator accurately to the channel frequency and inject the signal, modulated to 30% at 1000c/s, into the A43R aerial socket, SKT-G, at a level of 5 μ V.
- d. Connect the Voltmeter valve No 3, 1.5V a.c. range, via the diode head to pin 1 of the detector stage or to C171 on the top of the receiver deck. Set the Wattmeter a.f. No 1 to 300 Ω , 6mW and connect it to the audio output of the Test set radio, A43R.
- e. Tune the signal generator for a maximum reading of the valve voltmeter. Check the signal-to-noise ratio and note the result.
- f. Tune C101a for maximum reading of the valve voltmeter and at the same time ensure that the signal generator is accurately tuned for maximum output indication on the valve voltmeter.
- g. Trim consecutively, C104a, C108a and C161a for maximum reading on the valve voltmeter and again check the tuning of the signal generator for maximum valve voltmeter reading.
- h. Adjust C153a, C156a and C161a for maximum indication on the valve voltmeter repeating the signal generator check as before.
- j. Check and note the signal-to-noise ratio and a.f. output.
- k. Repeat for all channels and alternative channels if carried.

FAULT FINDING INFORMATION

TRANSMITTER

77. Typical test readings taken with an Avo multimeter model 8S or 9SX are given in Tables 5 and 6. All voltages are with respect to chassis and where voltages differ, due to the later modification to the send/receive delay, these are given at the end of Table 5.

Table 5 - Transmitter, typical test readings

Pins									
Valve	1	2	3	4	5	6	7	8	9
	-	G1	-	H	H	-	A	G2	-
V301	-	0	-	1.4	0.15	-	73	75	-
V302	-	-8.5	-	1.4	2.7	-	162	135	-
V303	-	-11.5	-	1.4	2.7	-	162	75	-
V304	-	-11.5	-	1.4	0	-	158	70	-
V305	-	-11.5	-	1.4	0	-	158	70	-
QQU02/6	G1a	-	G1b	-	H	Aa	G2	Ab	HCT
V306	-0.9	-	-0.9	-	-12	150	140	150	-6
*	G1a	Ha	Hb	Ab	G2b	Aa	Hb	Ha	G1b
QQZ02/6									
V306									
PHONE	-8.4	0	1.45ac	150	145	150	1.45ac	0	-9.0
BEACON	-6.6	0	1.2 ac	125	122	125	1.2 ac	0	-7.0
TONE									

*Note: The figures given for V306 (QQZ02/6) at the bottom of Table 5 refer to the later model A43R Mk 2 having the send/receive delay modification carried out.

Table 6 - Modulator and speech clipper, typical test readings

Transistor	Electrode multimeter reading		
	E	B	C
VT301	-0.8	-1.35	-11.0
VT302	0	-0.13	-11.3
VT303	0	-0.13	-11.3
VT201	-3.65	-3.7	-7.18
VT202	-3.68	-3.72	-7.0

Modulator

(VT301, VT302 and VT303)

78. a. Connect the test equipment as detailed in Fig 10 and 11.
- b. Connect the Wattmeter absorption a.f. No 1 across the secondary of T303. Set the impedance to 4kΩ and across the input terminals connect a 4kΩ 4W non-inductive resistor, to match the impedance of T303 secondary. Set the power range to 6W.

- f. Connect the audio oscillator, set to 1000c/s and high impedance output, via a 50 μ F 12V wkg electrolytic capacitor (positive to oscillator) in series with a 1k Ω composition resistor, to the junction of R329, R330 and R331 (see Fig 11).
- g. Switch on the stabilized power supply and adjust output to 11.75V. Check that the current drain is approximately 65mA.
- h. Connect either the Multimeter, electronic, CT471 or Voltmeter, valve, No 3, set to 1V range, across the output terminals of the audio source.
- j. The audio input level at 1000c/s should not exceed 1V when the wattmeter a.f. reads 2.5W. The output waveform displayed on the oscilloscope should not be flattened. At Base Workshop check that the distortion does not exceed 10% (total).
- k. Reduce the input level to give an output of 1W and vary the input frequency between 300c/s and 3000c/s keeping the input level constant. Output variation is to be less than \pm 3dB.
- l. On the later models of the A43R Mk 2 RLB does not exist. The connections made by its contacts are now permanently in circuit. The current drain detailed in sub-para g. is 30mA. Apart from these two differences the remainder of the tests apply.

RECEIVER

79. Typical test readings taken with the multimeter are given in Table 7. All voltages are with respect to chassis.

Table 7 - Receiver, typical test readings

Transistor	Electrode					
	E		B		C	
	Reading	Multimeter range (V)	Reading	Multimeter range (V)	Reading	Multimeter range (V)
VT101	0.25	3	0		-9.5	30
VT102	0.25	3	0		-9.2	30
VT103	-2.6	10	-2.7	10	-10.0	30
VT108	0.27	3	0.03		-12.0	30
VT109	0.27	3	0		-10.5	30
VT110	0.25	3	0		-10.5	30
VT111	0.2	3	0		-11.7	30
VT112	0.2	3	0		-11.7	30
VT114	-1.0	3	0		-12.5	30
VT115	0	3	-0.02	3	-12.5	30
VT116			-0.57	3	-7.2	30
VT117	-4.0	10	-3.2	10	-12.5	30

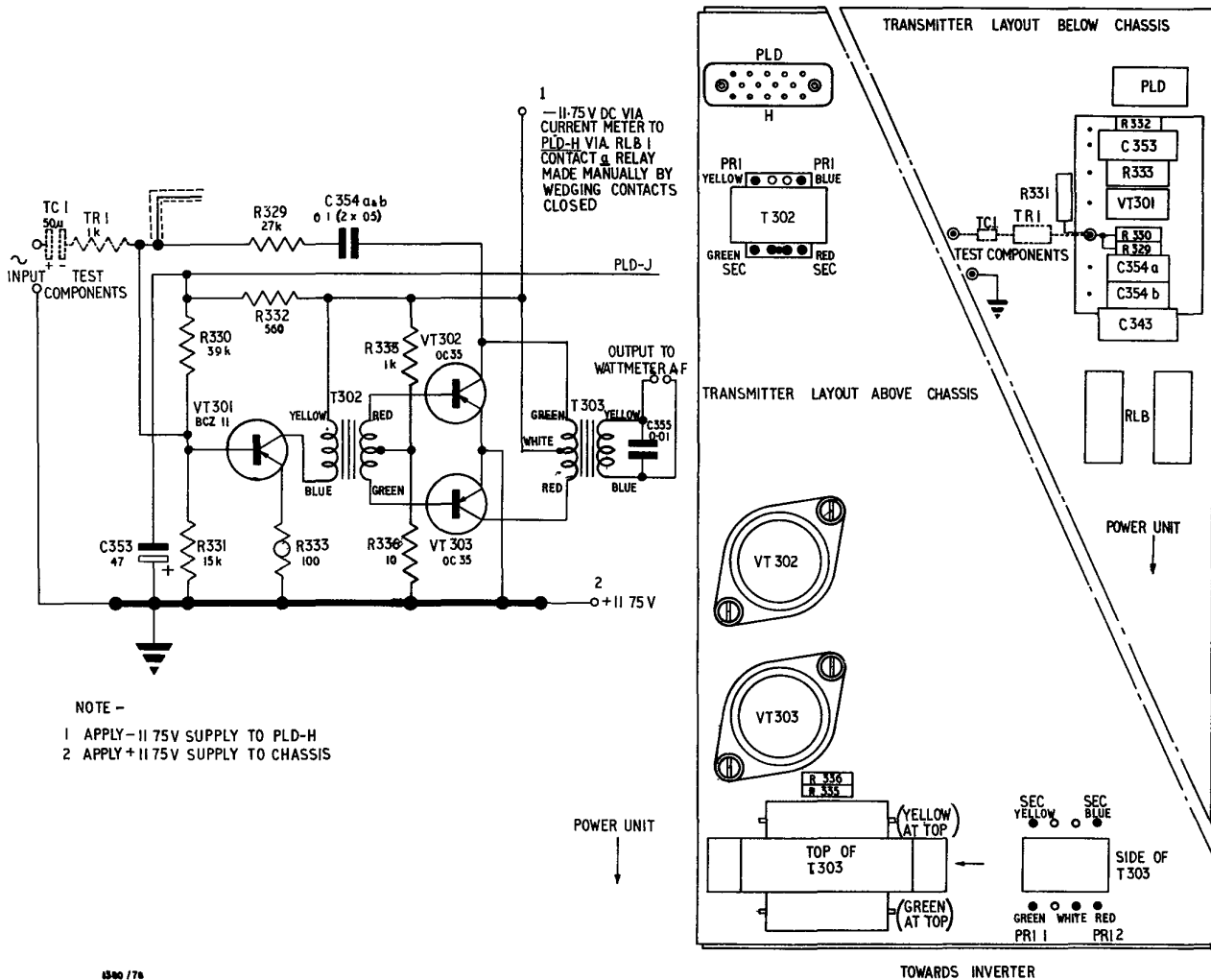

Fig 11 - Modulator, test connection detail

80. Typical signal input voltages to give 7mW at the headphone terminals with the volume control set fully clockwise.

a. Audio stages with a signal input of 400c/s via 1μF capacitor.

Test point	Input
Pin 1 detector sub-unit	275mV
VT117 base	270mV
VT117 emitter	3.2V
VT116 base	0.9V.

- b. 2nd i.f. stages with a signal input frequency of 930kc/s modulated to 30% at 1000c/s. Input to the test points is via a 0.1 μ F capacitor.

<u>Test point</u>	<u>Input</u>
I.F. detector unit pin 6	4.5mV
I.F. amplifier pin 6 (VT106)	90 μ V
I.F. filter pin 1	250 μ V
I.F. filter pin 6	1.4mV
Mixer (VT105)	30 μ V

- c. 1st i.f. stages with a signal input frequency of 19.050Mc/s modulated to 30% at 1000c/s. Input to test points is via a 0.1 μ F capacitor.

<u>Test point</u>	<u>Input</u>
I.F. frequency to mixer pin 6 (VT105)	40 μ V
I.F. amplifier pin 6 (VT104)	18 μ V
I.F. filter	40 μ V
1st mixer VT103 base	32 μ V
1st mixer VT103 emitter	4-5 μ V

Protection circuit efficiency

81. To check that the protection circuit is operating satisfactorily carry out the following tests:

- a. Connect the test equipment as detailed in Fig 9 with the r.f. power meter (CT419) replacing the signal generator.
- b. Select the highest channel frequency.
- c. Release the four socket headed No 4 BA screws securing the receiver deck to the main chassis.
- d. Swing back the receiver deck and remove the two receiver channel tuners that have been selected (the highest frequency) and place them in the channel tuner clips on the turret stator (goal post assembly) Fig 4010).
- e. Connect the valve voltmeter No 3, set to the 1.5V a.c. range, across C105.
- f. Set the stabilized power supply to give 11.5V and the test set radio switches as follows: BATTERY LOAD TEST to OFF, MIC to OFF and PHONE to OFF.
- g. Put the SYSTEM switch to BEACON TONE and ensure that the r.f. power output indicated on the r.f. power meter (CT419) is not less than 2W.
- h. The audio voltage measured across C105 must be less than 300mV. Switch off the A43R, remove the channel tuners from the clips and replace in the ~~turret~~. Re-assemble the receiver deck.
- j. Check that the receiver is functioning on all channels.

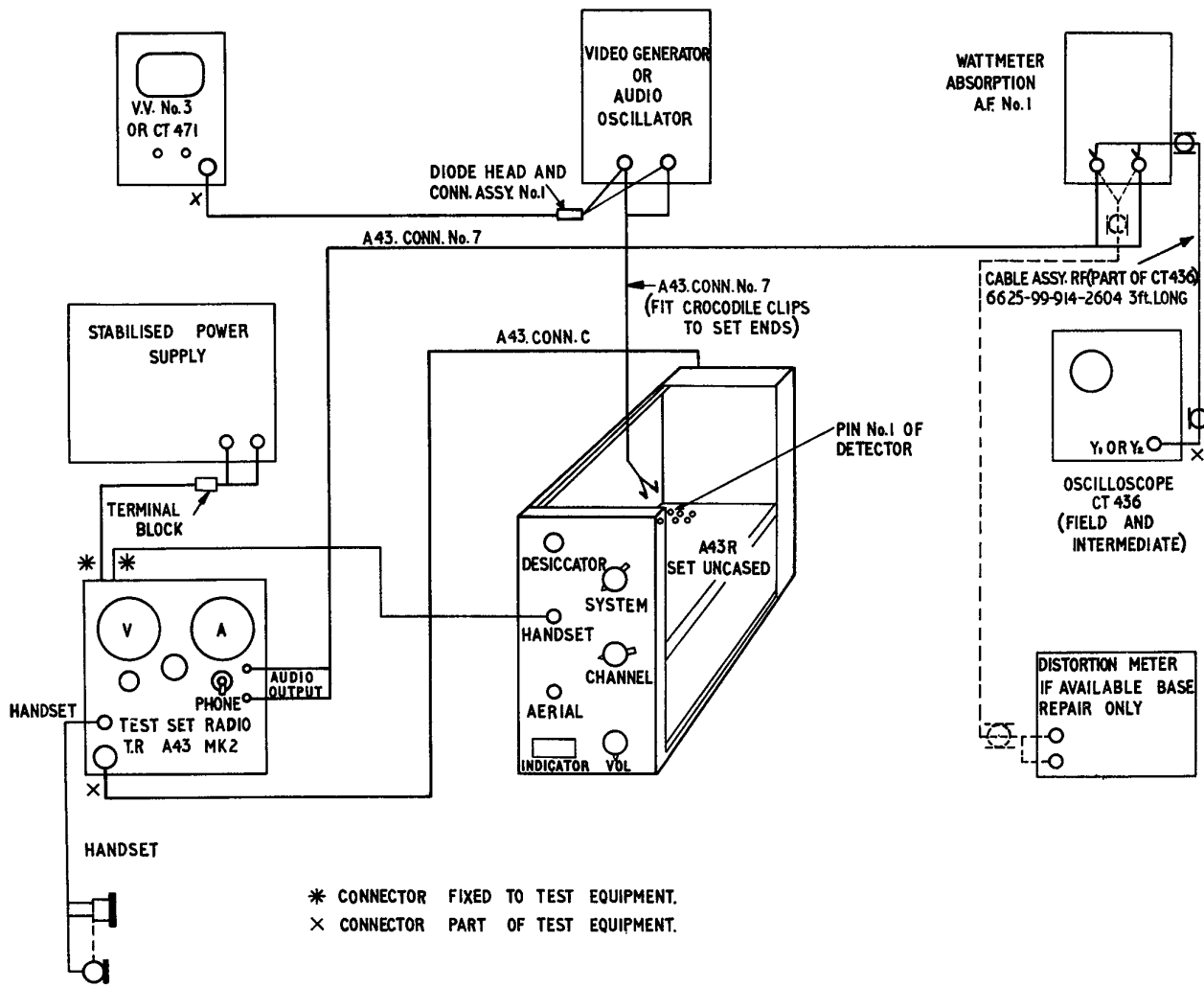

Fig 12 - A.F. response, test layout

Audio stage response

82. a. Connect the test equipment as detailed in Fig 12.
- b. Disconnect the screened lead from pin 1 of the detector sub-unit and connect the audio oscillator, set to high impedance, to this lead via a series 27kΩ resistor shunted to chassis by a 2000μF capacitor. Monitor the a.f. input with a valve voltmeter.

- c. Connect the Wattmeter, absorption, a.f. No 1 set to 300Ω impedance and 6mW power range, to the audio output terminals of the Test set radio A43R.
- d. Set the stabilized power supply to 12.5V, the A43R VOLUME control to maximum and the test set, radio, PHONE switch to OFF.
- e. With the audio oscillator input set to 400c/s at 250mV, the a.f. output is to be greater than 5mW.
- f. Set the A43R VOLUME control to give an output reading of 4mW. The waveform displayed on the oscilloscope (CT436) must not be flattened.
- g. Set the audio oscillator to 1000c/s at 250mV and adjust the A43R VOLUME control to give a reading of 2mW. Keeping the audio input level constant, vary the frequency and check that the output conforms to the figures given below:

300c/s	-	+2dB to -1dB
1000c/s	-	0dB - reference level
3000c/s	-	-3dB to -8dB
6000c/s	-	-11dB

POWER SUPPLY UNIT

Output voltages

83. Remove the desiccator from the front panel of the A43R to obtain access to the B7G valve holder (test socket SKT-L) and insert the Adaptor, test. Fit the Adaptor extension panel, A43R Connector No 9 to the Adaptor test. Check the voltages with the multimeter.

a. Transmitter 150V d.c.	pin 5	142V to 158V
b. Transmitter 75V d.c.	pin 6	71V to 79V
c. Transmitter filament	pin 3	3.05V to 3.35V
d. Transmitter filament, later models		1.2V to 1.5V a.c.

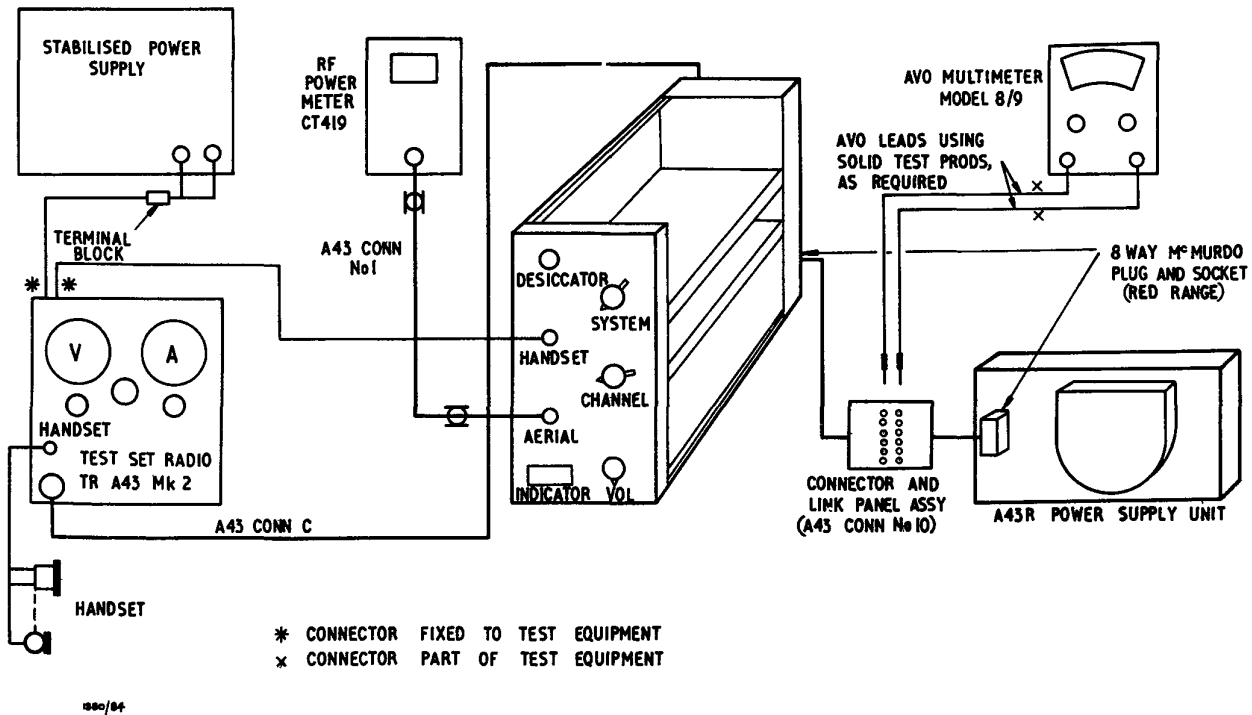

Fig 13 - Power supply unit, test layout (A43R load)

Output currents and ripple voltage

84. Connect the test equipment as shown in Fig 13. Check current and ripple voltage as follows, with input voltage set to 11.5V d.c.

- | | |
|-------------------------------------|---|
| <p>a. Transmitter 150V d.c.</p> | <p>Remove the link screw from the 150V line and connect the multimeter, 1A range, across the test sockets. Switch the A43R to PHONE and the test set radio PRESSEL to ON. Check that the current is approximately 110mA. Check that the ripple voltage as measured on the oscilloscope (CT436) is about 1.5V p-p.</p> |
| <p>b. Transmitter 75V d.c.</p> | <p>Repeat the above procedure on the 75V line. Check that the current is approximately 18mA and the ripple voltage 800mV p-p.</p> |
| <p>c. Transmitter filament 3.2V</p> | <p>Repeat the procedure on the 3.2V line. Check the current is approximately 490mA and the ripple voltage is 60mV p-p.</p> |

d. Transmitter p.a. filament, (later models).

Repeat the above procedure on the P.A.FIL. line and check that the current is approximately 3A. a.c.

85. It is recommended, that for Base workshops repairs a resistive load be used in place of the A43R. Details of a suitable load are given in Fig 4004. Connect the equipment as detailed in Fig 14 and carry out testing as in para 86. Ripple figures are unchanged but there is no superimposed ripple on the 150V line due to the transmitter load. See Fig 15 item 5.

- | | |
|--------------------------|---------------------------------|
| a. Transmitter 150V d.c. | Current 148mA, ripple 1.5V p-p |
| b. Transmitter 75V d.c. | Current 18mA, ripple 800mV p-p |
| c. Transmitter 3.2V d.c. | Current 490mA, ripple 60mV p-p. |

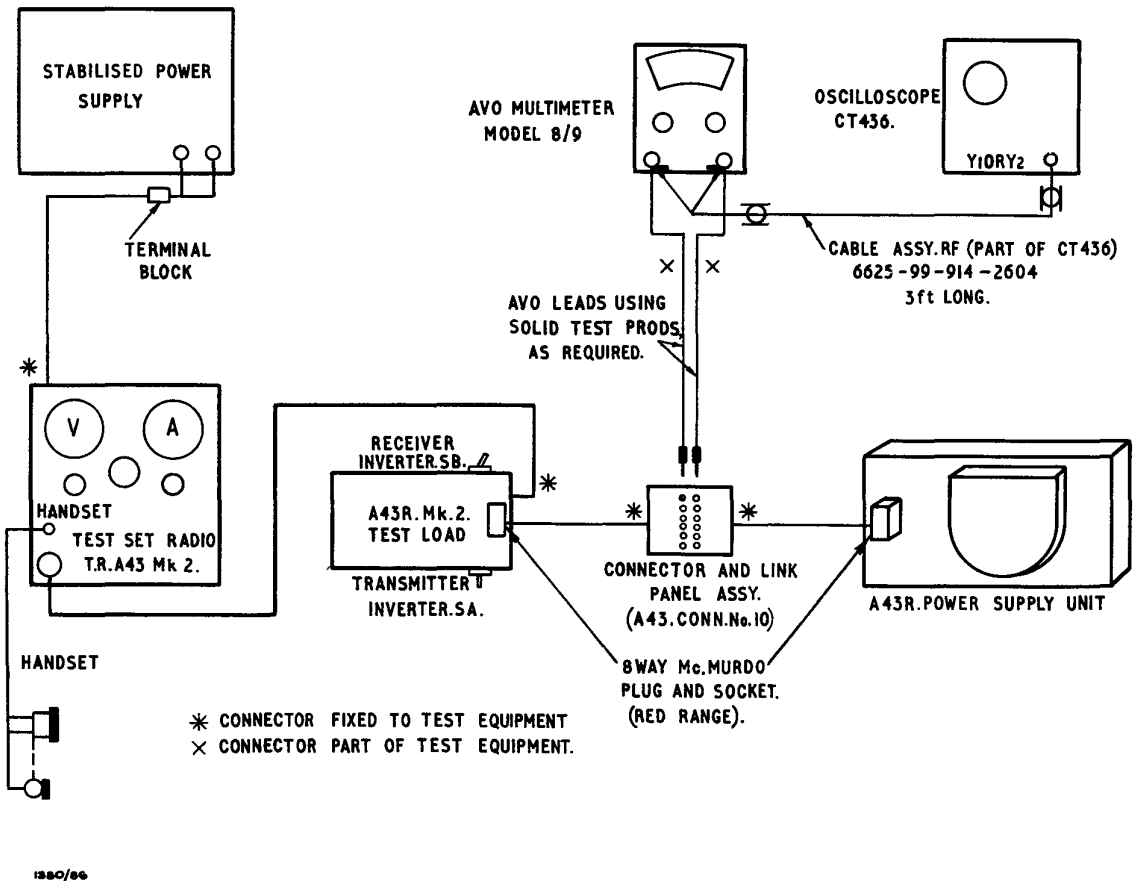
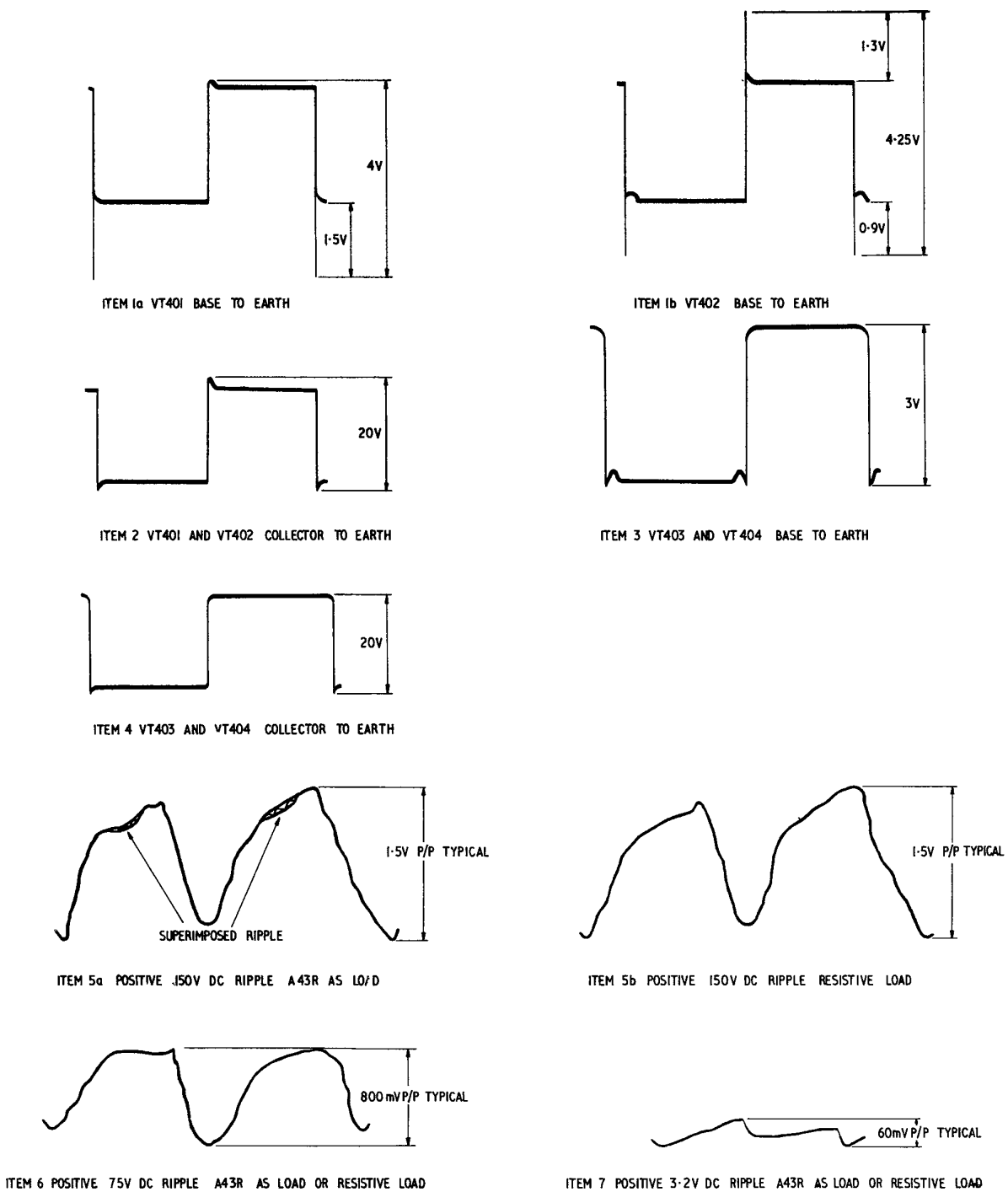

Fig 14 - Power supply unit, test layout (resistive load)

86. a. Typical waveforms obtained on an oscilloscope (CT436) are shown in Fig 15.
- b. The efficient operation of the inverter circuits depend upon the similarity of the characteristics of VT401 and VT402 and also VT403 and VT404.
- c.. The toroid transformers T401 and T402 are normally not liable to fail but may be damaged by incorrect supply voltage, overloading or malfunction of other components. If T401 and/or T402 are replaced the transistors used in the primary circuits may also require replacing.
- d. The diodes MR401-404 used in the +150V and +75V inverter part of the p.s.u. must each possess a low forward resistance and a high reverse resistance to ensure maximum efficiency and lowest ripple. This also applies to the diodes MR406 and MR407 used in the +3.2V output.



1800/70

Fig 15 - Power supply unit, waveforms and ripple characteristics

BATTERY CHARGER

87. Typical voltage and current readings taken with the multimeter are given in Table 8. Fig 16 details the waveform obtained on an oscilloscope (CT436) during correct operation of the equipment.

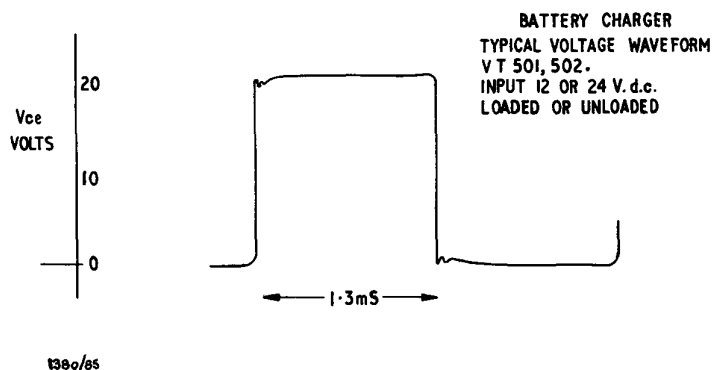

Fig 16 - Battery charger waveform

Table 8 - Battery charger, voltage and current readings

Note: Voltage readings given are with multimeter positive lead connected to chassis.	Supply voltage			
	11	16	22	30
Input current (no load)	0.405A	0.54A	0.265A	0.36A
Input current (1A load)	2.0A	2.15A	1.05A	1.15A
Input current regulator disconnected	0.175A	0.265A	0.16A	0.235A
Base voltage VT501/502	1.0V	1.45V	1.05V	1.4V
VT501 p-p				
VT504 collector (no load)	12.5V	23.3V	12.4V	21.1V
VT504 base (no load)	5.2V	5.2V	5.3V	5.3V
VT504 emitter (no load)	5.1V	5.2V	5.2V	5.2V
VT505 collector (no load)	13.5V	13.4V	13.6V	13.5V
VT505 base (no load)	5.2V	5.3V	5.3V	5.3V
VT503 collector (no load)	16.7V	25.0V	15.6V	23.5V
VT503 emitter (no load)	13.4V	13.3V	13.4V	13.3V
Converter output volts (no load)	16.8V	25.0V	16.8V	23.2V
VT506 collector on 1A load	13.2V	21.6V	14.3V	20.6V
VT506 emitter on 1A load	13.2V	13.2V	13.2V	13.2V

Note: The next page is Page 1001

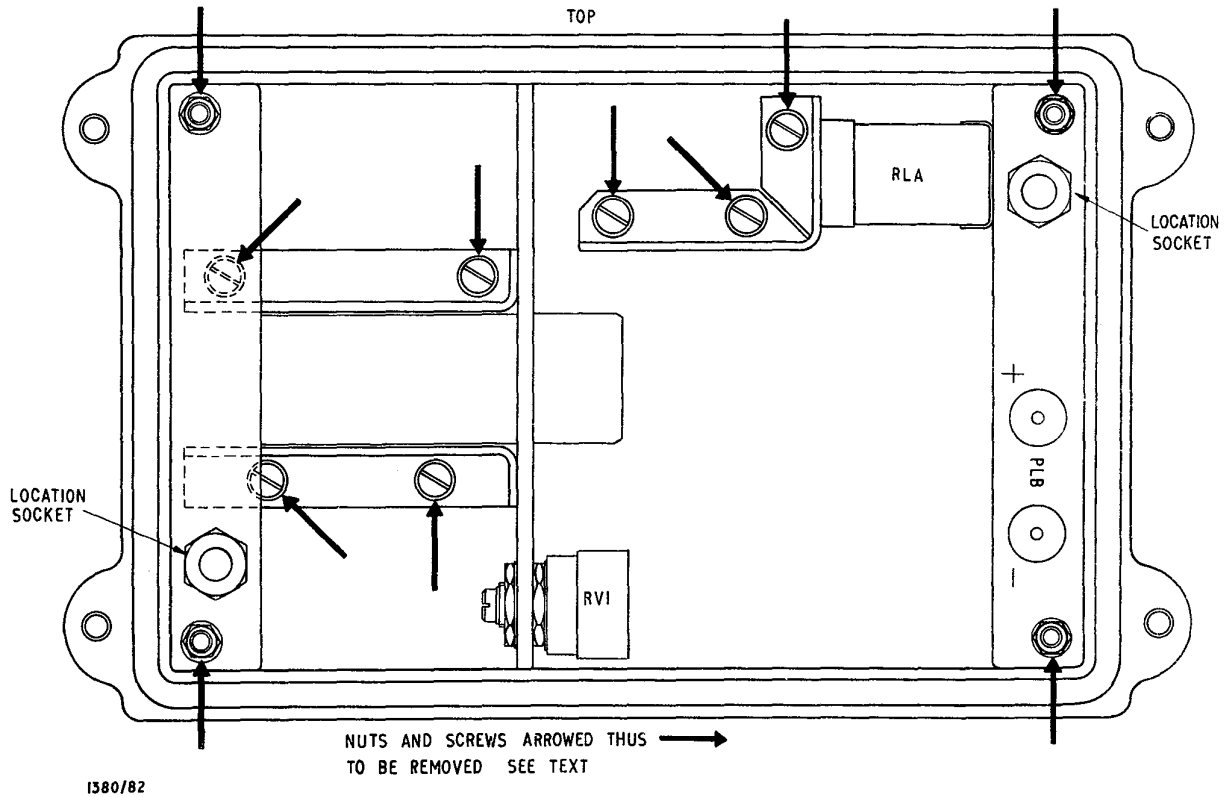
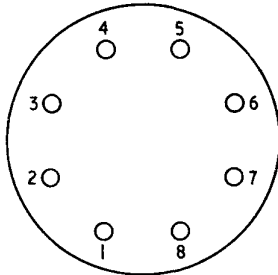

Fig 4001 - Battery charger, layout of fittings

CV 2105
DL70 *
(SUB MIN RF OUTPUT PENT)
BASE BS448/B80/F



- | | |
|-------------------------|---------------------------|
| 1 IC | 5 HEATER |
| 2 g ¹ (CONT) | 6 NC |
| 3 NC (NOT CONNECTED) | 7 a (ANODE) |
| 4 HEATER & SUPP | 8 g ² (SCREEN) |

CV 2299
DL73 *
(SUB MIN PENT)
BASE BS448/B80/F AS CV2105

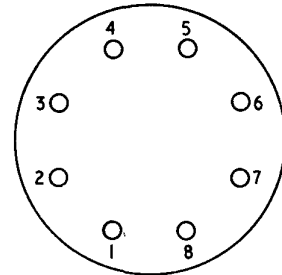

- | | |
|-------------|---------------------------|
| 5 HEATER | 6 NC |
| 7 a (ANODE) | 8 g ² (SCREEN) |

CV 2466
QQU02/6 *

BASE BS448/B9A

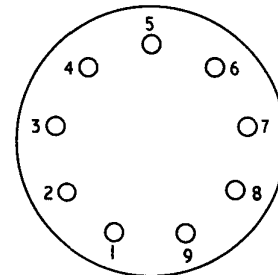

- | | |
|---------------------------|------------------------------------|
| 1 g ¹ (CONT 1) | 5 h (HEATER) |
| 2 k AND S (CATH & SHIELD) | 6 a ¹ (ANODE) |
| 3 g ¹ (CONT 2) | 7 g ² (SCREEN 2 COMMON) |
| 4 h (HEATER) | 8 a ² (ANODE) |
| | 9 h (HEATER CENTRE TAP) |

CV 2980
DM70 *

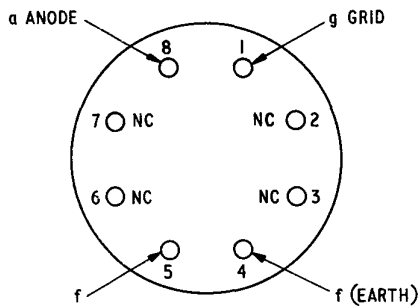

CV 9322
QQZ 02/6 *

CV 7069
SX56

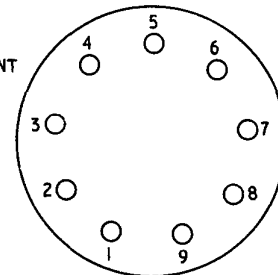
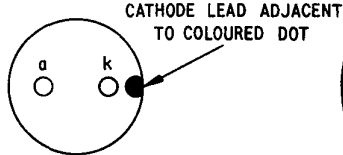

- | | |
|--------------------|--------------------|
| 1 g ¹ a | 5 g ² a |
| 2 h | 6 a ² |
| 3 h | 7 h |
| 4 a ¹ | 8 h |
| | 9 g ¹ b |

CV 7122
GEX 541 *

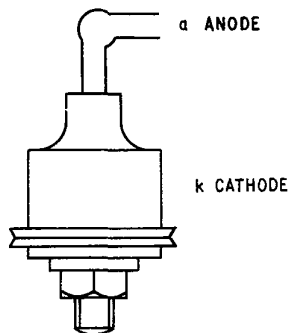

CV 7039
GJ5M

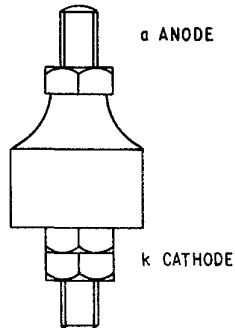

CV 7036
GJ4M

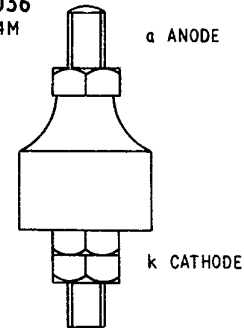

* VIEW LOOKING ON BASE

1380/99

Fig 4002 - A/3P valve and semi-conductor diode, connection details

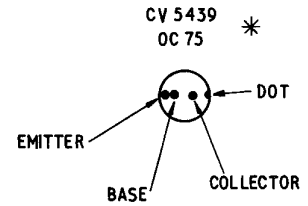
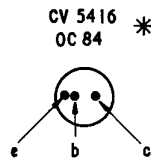
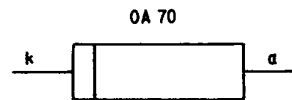
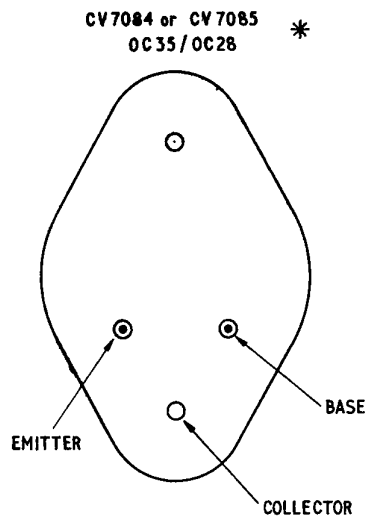
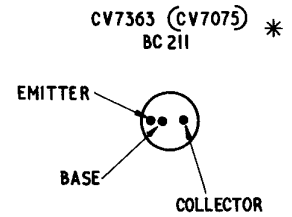
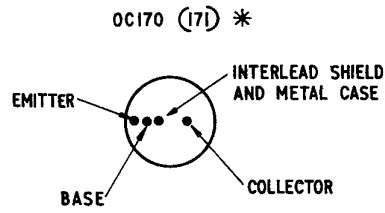
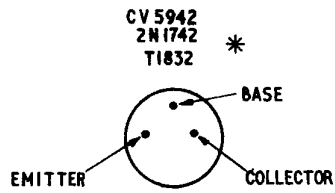

* VIEW LOOKING ON BASE

1880/77

Fig 4003 - A43R semi-conductor, connection details

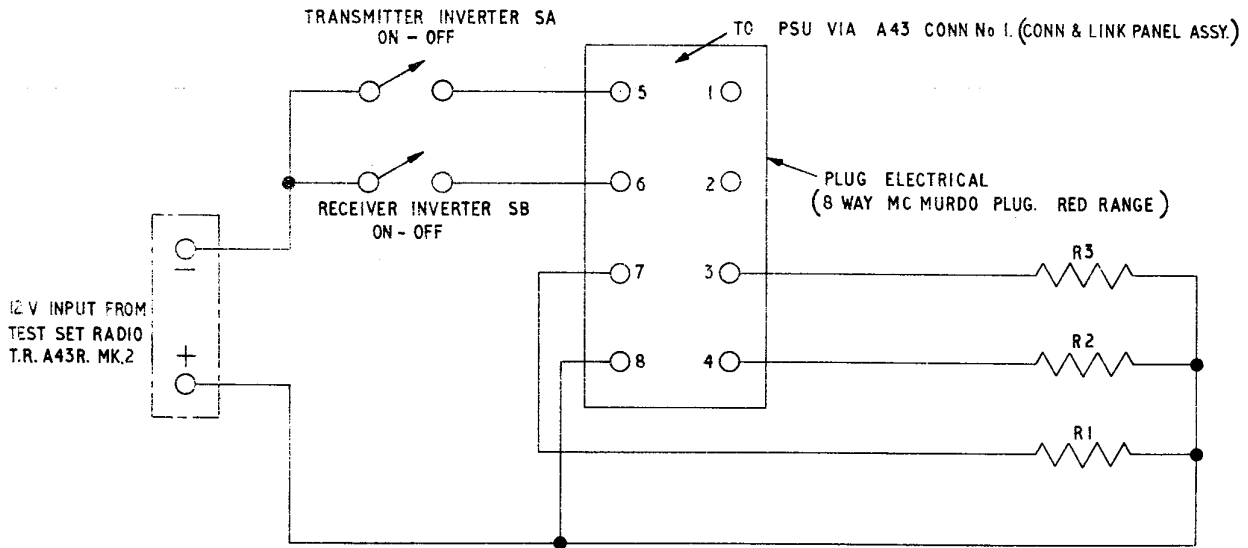

COMPONENT	TYPE	CAT. No.
SWITCH SA	3A SINGLE POLE	5930-99-051-0551
SWITCH SB	3A SINGLE POLE	5930-99-051-0551
PLUG ELEC (INPUT)	Mk 4 BRASS 2 POLE	5935-99-940-3239
OUTLET, ANGLE, SMALL	2 POLE	5935-99-911-7969
PLUG ELEC	UNITOR 8 POLE No.102	Z/5935-99-056-2502
RESISTOR R1	960Ω 25W 5% W.W. VITREOUS EN.	
RESISTOR R2	4Ω 6W 5% W.W. VITREOUS EN.	
RESISTOR R3	6Ω 6W 5% W.W. VITREOUS EN.	
WIRE EQPT RED	40/0076 TYPE 2 DEF 12	6145-99-910-0227
WIRE EQPT BLACK	40/0076 TYPE 2 DEF 12	6145-99-942-4124

no/92

Fig 4004 - A43R power supply unit resistive load details

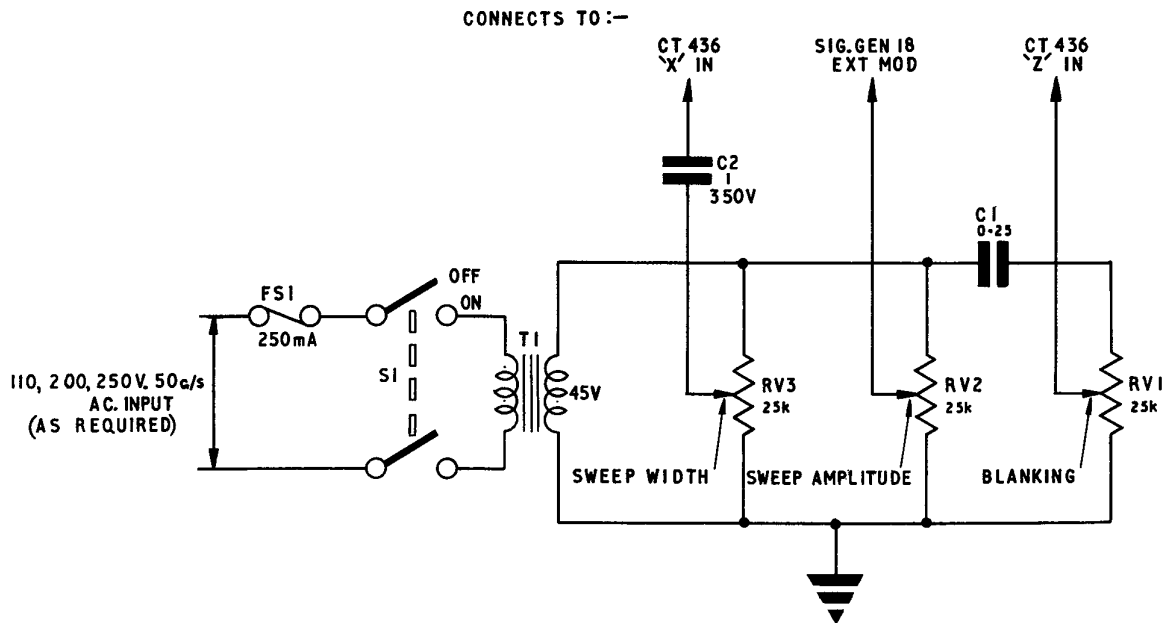

NOTE. RV1.2.3 ARE WIRE WOUND POTENTIOMETERS.

1380/91

Fig 40C5 - Sweep source for external modulation of Signal generator 18

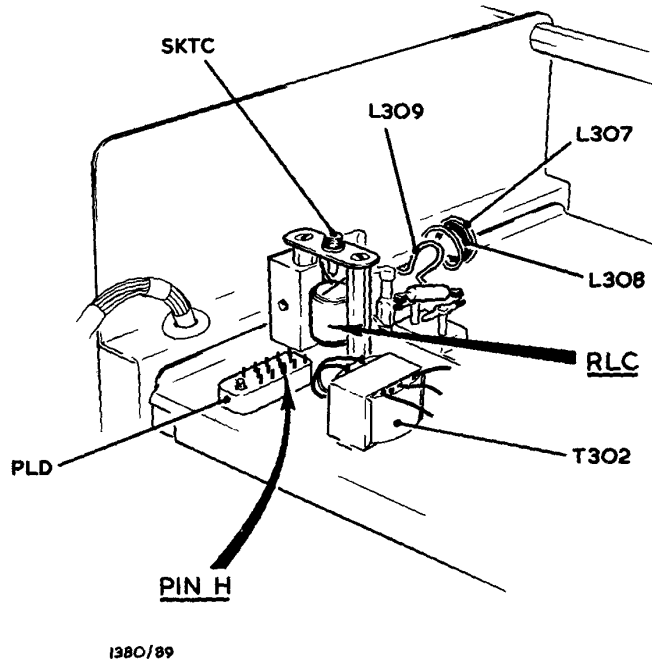

Fig 4006 - Relay RLC, location

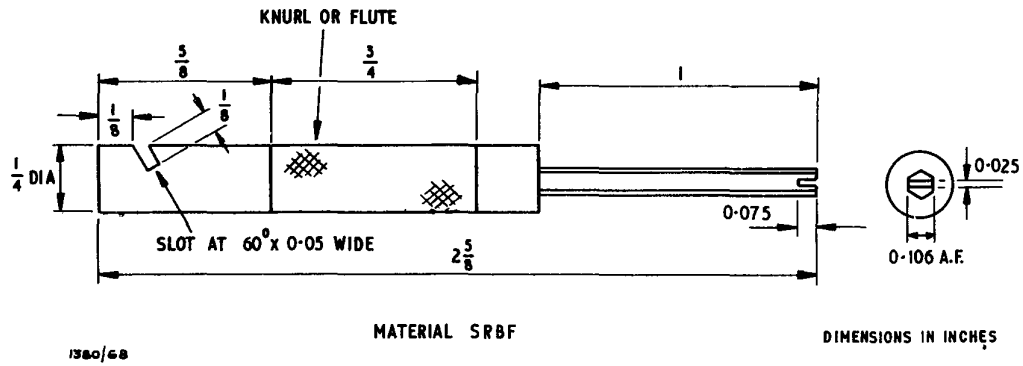

Fig 4008 - I.F. trimming tool

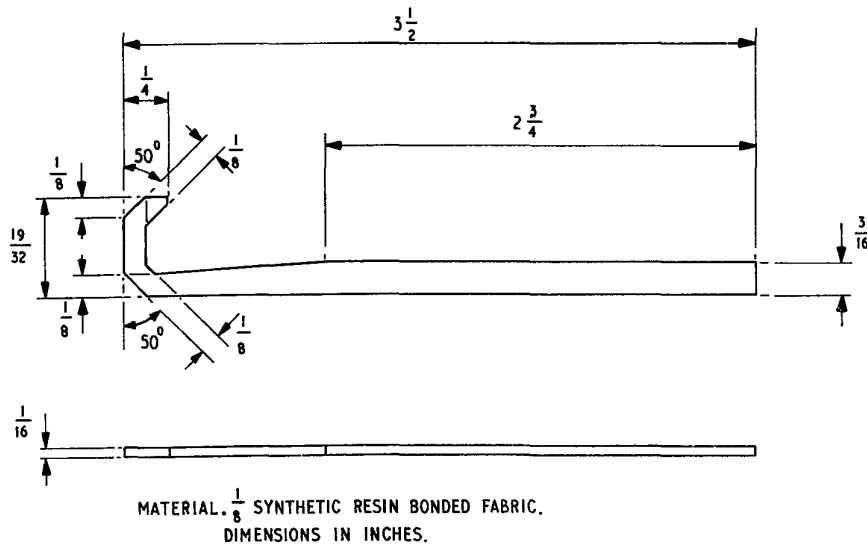

Fig 4009 - Channel tuner (biscuit) removing tool

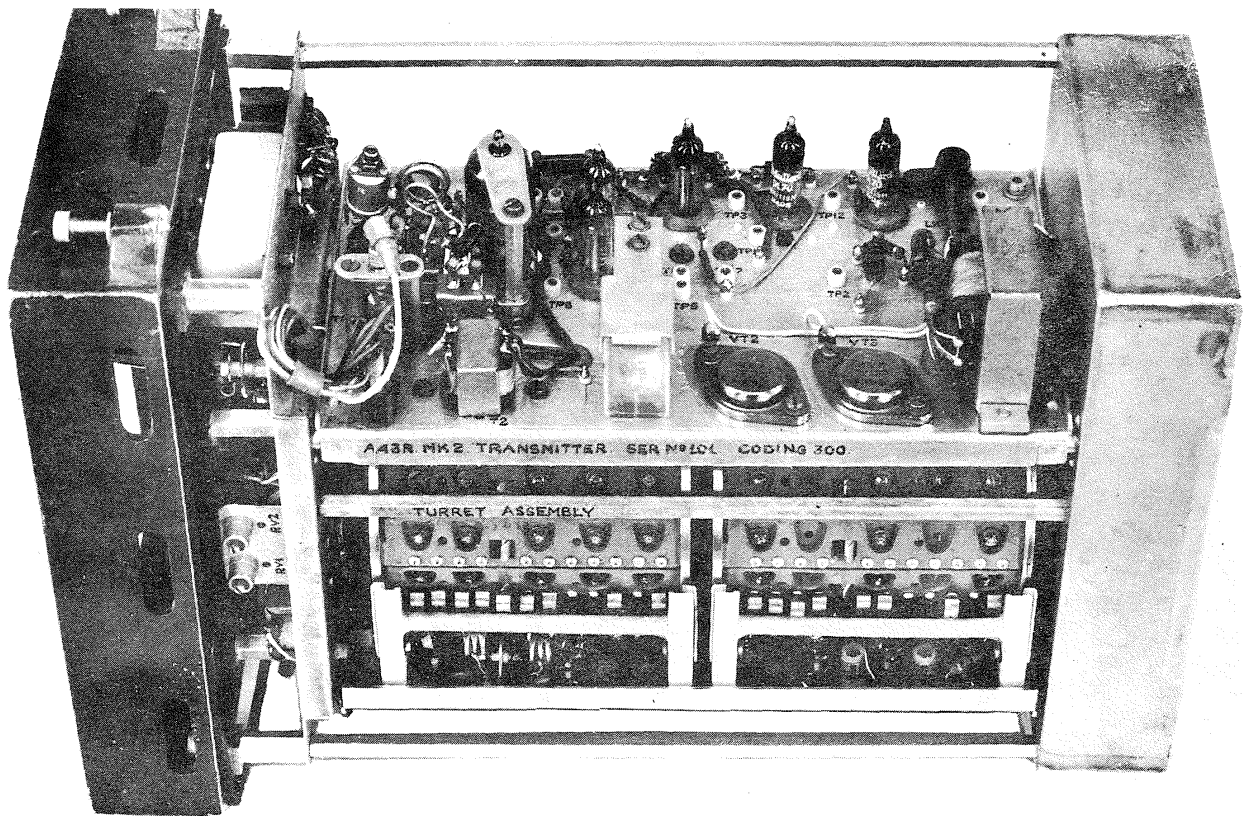

Fig 4010 - Receiver contacts

Notes on the adjustment of turret contacts:

The correct clearance between turret insulant and stator contacts is 0.015 \pm 0.005 in. for both transmitter and receiver sections.

Release the receiver deck and swing out as shown in Fig 4011. This gives access to the transmitter contacts.

Remove a biscuit from each half of the turret and rotate the CHANNEL switch slowly anti-clockwise until the gap is facing the stator contacts. Using the straight end of the biscuit removing tool, Fig 4009, gently depress each contact until it appears level with the edge of the adjacent insulant. Rotate the CHANNEL switch again anti-clockwise to bring the next biscuit insulant under the contacts and adjust the gap to 0.015 in. Play in the biscuit mounting may allow rocking or see-sawing and this must be borne in mind when making adjustments at either end of each biscuit. Replace the biscuits.

Rotate the CHANNEL switch through all positions checking that the gap between turret insulant and stator contacts is 0.015 in. \pm 0.005 in. and that contact lift is adequate, eg: Turret contact "rivets" are approximately 0.043 in. high so that a stator clearance of 0.015 in. will result in a lift of 0.043 in. -0.015 in. or 0.028 in.

Receiver adjustment is similar to the above but the deck is replaced in the operating position as shown in Fig 4010.

Should the biscuit removing tool not be available a suitable tool may be fashioned from 1/4 in. dia. ebonite rod filed to a screw-driver blade shape at one end.

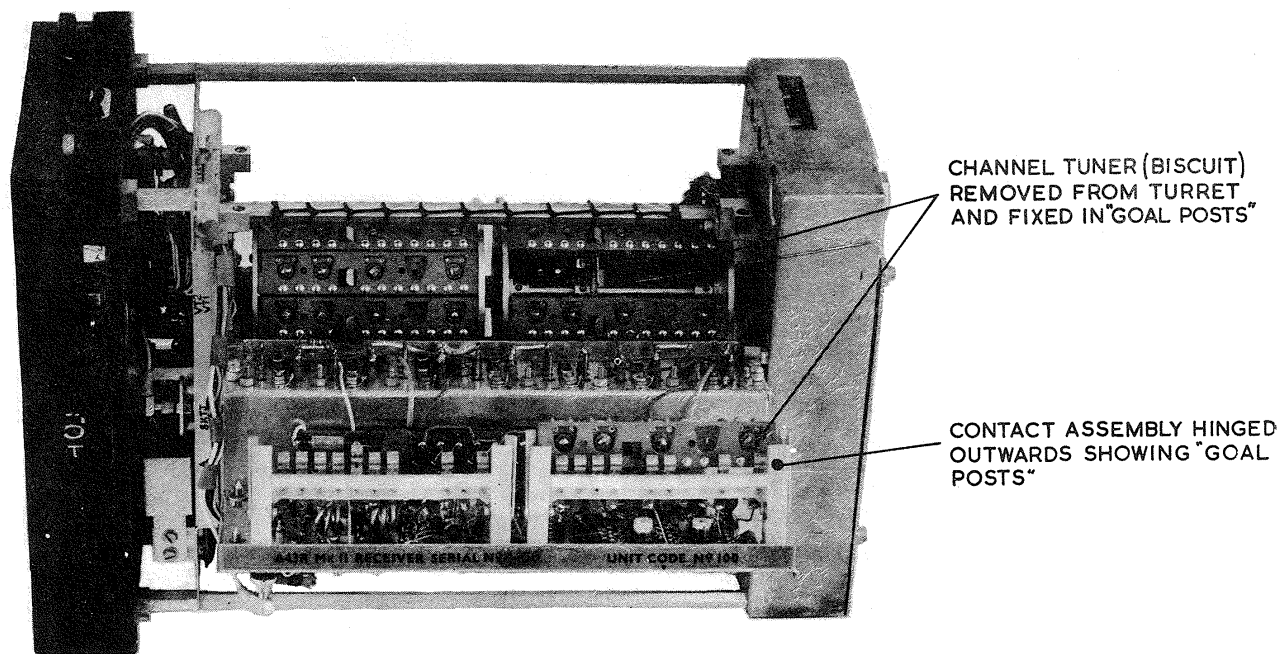

Fig 4011 - Channel tuner in goal post assembly